

SONY[®]

4-448-425-13(1)

Multi Channel AV Receiver

Operating Instructions

STR-DH540

WARNING

To reduce the risk of fire or electric shock, do not expose this apparatus to rain or moisture.

To reduce the risk of fire, do not cover the ventilation opening of the appliance with newspapers, tablecloths, curtains, etc. Do not expose the appliance to naked flame sources (for example, lighted candles).

To reduce the risk of fire or electric shock, do not expose this appliance to dripping or splashing, and do not place objects filled with liquids, such as vases, on the appliance.

Do not install the appliance in a confined space, such as a bookcase or built-in cabinet.

As the main plug is used to disconnect the unit from the mains, connect the unit to an easily accessible AC outlet. Should you notice an abnormality in the unit, disconnect the main plug from the AC outlet immediately.

Do not expose batteries or appliances with battery-installed to excessive heat, such as sunshine and fire.

The unit is not disconnected from the mains as long as it is connected to the AC outlet, even if the unit itself has been turned off.

Excessive sound pressure from earphones and headphones can cause hearing loss.



This symbol is intended to alert the user to the presence of the Hot Surface that may be hot if it is touched during the normal operation.

For customers in the United States

Owner's Record

The model and serial numbers are located on the rear of the unit. Record these numbers in the space provided below. Refer to them whenever you call upon your Sony dealer regarding this product.

Model No. _____

Serial No. _____



This symbol is intended to alert the user to the presence of uninsulated "dangerous voltage" within the product's enclosure that may be of sufficient magnitude to constitute a risk of electric shock to persons.



This symbol is intended to alert the user to the presence of important operating and maintenance (servicing) instructions in the literature accompanying the appliance.

Important Safety Instructions

- 1) Read these instructions.
- 2) Keep these instructions.
- 3) Heed all warnings.
- 4) Follow all instructions.
- 5) Do not use this apparatus near water.
- 6) Clean only with dry cloth.
- 7) Do not block any ventilation openings. Install in accordance with the manufacturer's instructions.
- 8) Do not install near any heat sources such as radiators, heat registers, stoves, or other apparatus (including amplifiers) that produce heat.

- 9) Do not defeat the safety purpose of the polarized or grounding-type plug. A polarized plug has two blades with one wider than the other. A grounding type plug has two blades and a third grounding prong. The wide blade or the third prong are provided for your safety. If the provided plug does not fit into your outlet, consult an electrician for replacement of the obsolete outlet.
- 10) Protect the power cord from being walked on or pinched particularly at plugs, convenience receptacles, and the point where they exit from the apparatus.
- 11) Only use attachments/accessories specified by the manufacturer.
- 12) Use only with the cart, stand, tripod, bracket, or table specified by the manufacturer, or sold with the apparatus. When a cart is used, use caution when moving the cart/apparatus combination to avoid injury from tip-over.



- 13) Unplug this apparatus during lightning storms or when unused for long periods of time.
- 14) Refer all servicing to qualified service personnel. Servicing is required when the apparatus has been damaged in any way, such as power-supply cord or plug is damaged, liquid has been spilled or objects have fallen into the apparatus, the apparatus has been exposed to rain or moisture, does not operate normally, or has been dropped.

The following FCC statement applies only to the version of this model manufactured for sale in the U.S.A. Other versions may not comply with FCC technical regulations.

NOTE:

This equipment has been tested and found to comply with the limits for a Class B digital device, pursuant to Part 15 of the FCC Rules. These limits are designed to provide reasonable protection against harmful interference in a residential installation. This equipment generates, uses and can radiate radio frequency energy and, if not installed and used in accordance with the instructions, may cause harmful interference to radio communications. However, there is no guarantee that interference will not occur in a particular installation. If this equipment does cause harmful interference to radio or television reception, which can be determined by turning the equipment off and on, the user is encouraged to try to correct the interference by one or more of the following measures:

- Reorient or relocate the receiving antenna.
- Increase the separation between the equipment and receiver.
- Connect the equipment into an outlet on a circuit different from that to which the receiver is connected.
- Consult the dealer or an experienced radio/TV technician for help.

CAUTION

You are cautioned that any changes or modifications not expressly approved in this manual could void your authority to operate this equipment.

Properly shielded and grounded cables and connectors must be used for connection to host computers and/or peripherals in order to meet FCC emission limits.

To reduce the risk of electric shock, the speaker cord should be connected to the apparatus and the speakers in accordance with the following instructions.

- 1) Disconnect the AC power cord from the MAINS.
- 2) Strip 10 to 15 mm of the wire insulation of the speaker cord.
- 3) Connect the speaker cord to the apparatus and the speakers carefully so as not to touch the core of speaker cord by hand. Also disconnect the AC power cord from the MAINS before disconnecting the speaker cord from the apparatus and the speakers.

For customers in Canada

Properly shielded and grounded cables and connectors must be used for connection to host computers and/or peripherals.

For customers in Europe



Disposal of Old Electrical & Electronic Equipment (Applicable in the European Union and other European countries with separate collection systems)

This symbol on the product or on its packaging indicates that this product shall not be treated as household waste. Instead it shall be handed over to the applicable collection point for the recycling of electrical and electronic equipment. By ensuring this

product is disposed of correctly, you will help prevent potential negative consequences for the environment and human health, which could otherwise be caused by inappropriate waste handling of this product. The recycling of materials will help to conserve natural resources. For more detailed information about recycling of this product, please contact your local Civic Office, your household waste disposal service or the shop where you purchased the product.



Disposal of waste batteries (applicable in the European Union and other European countries with separate collection systems)

This symbol on the battery or on the packaging indicates that the battery provided with this product shall not be treated as household waste.

On certain batteries this symbol might be used in combination with a chemical symbol. The chemical symbols for mercury (Hg) or lead (Pb) are added if the battery contains more than 0.0005% mercury or 0.004% lead.

By ensuring these batteries are disposed of correctly, you will help prevent potentially negative consequences for the environment and human health which could otherwise be caused by inappropriate waste handling of the battery. The recycling of the materials will help to conserve natural resources.

In case of products that for safety, performance or data integrity reasons require a permanent connection with an incorporated battery, this battery should be replaced by qualified service staff only.

To ensure that the battery will be treated properly, hand over the product at end-of-life to the applicable collection point for the recycling of electrical and electronic equipment.

For all other batteries, please view the section on how to remove the battery from the product safely. Hand the battery over to the applicable

collection point for the recycling of waste batteries.

For more detailed information about recycling of this product or battery, please contact your local Civic Office, your household waste disposal service or the shop where you purchased the product.

Notice for customers: The following information is only applicable to equipment sold in countries applying EU Directives.

This product has been manufactured by or on behalf of Sony Corporation, 1-7-1 Konan Minato-ku Tokyo, 108-0075 Japan. Inquiries related to product compliance based on European Union legislation shall be addressed to the authorized representative, Sony Deutschland GmbH, Hedelfinger Strasse 61, 70327 Stuttgart, Germany. For any service or guarantee matters, please refer to the addresses provided in the separate service or guarantee documents.

For customers in Australia



Disposal of Old Electrical & Electronic Equipment (Applicable in the European Union and other European countries with separate collection systems)

About This Manual

- The instructions in this manual are for model STR-DH540. The model number is located at the lower right corner of the front panel. The illustrations used in this manual are of the Europe model and they may be different from your model. Any differences in operation are marked in the manual as “Europe model only”.
- The instructions in this manual describe the operation of the receiver with the supplied remote control. You can also use the buttons or knobs on the receiver if they have the same or similar names as those on the remote control.

On copyrights

This receiver incorporates Dolby* Digital and Pro Logic Surround and the DTS** Digital Surround System.

- * Manufactured under license from Dolby Laboratories. Dolby, Pro Logic, and the double-D symbol are trademarks of Dolby Laboratories.
- ** Manufactured under license under U.S. Patent Nos: 5,956,674; 5,974,380; 6,226,616; 6,487,535; 7,212,872; 7,333,929; 7,392,195; 7,272,567 & other U.S. and worldwide patents issued & pending. DTS-HD, the Symbol, & DTS-HD and the Symbol together are registered trademarks of DTS, Inc. Product includes software. © DTS, Inc. All Rights Reserved.

This receiver incorporates High-Definition Multimedia Interface (HDMI™) technology. The terms HDMI and HDMI High-Definition Multimedia Interface, and the HDMI Logo are trademarks or registered trademarks of HDMI Licensing LLC in the United States and other countries.

iPhone, iPod, iPod classic, iPod nano, and iPod touch are trademarks of Apple Inc., registered in the U.S. and other countries.

All other trademarks and registered trademarks are of their respective holders. In this manual, ™ and ® marks are not specified.

“Made for iPod” and “Made for iPhone” mean that an electronic accessory has been designed to connect specifically to iPod or iPhone, respectively, and has been certified by the developer to meet Apple performance standards.

Apple is not responsible for the operation of this device or its compliance with safety and regulatory standards. Please note that the use of this accessory with iPod or iPhone may affect wireless performance.

Windows Media is either a registered trademark or trademark of Microsoft Corporation in the United States and/or other countries.

This product is protected by certain intellectual property rights of Microsoft Corporation. Use or distribution of such technology outside of this product is prohibited without a license from Microsoft or an authorized Microsoft subsidiary.

MPEG Layer-3 audio coding technology and patents licensed from Fraunhofer IIS and Thomson.

“x.v.Color (x.v.Colour)” and “x.v.Color (x.v.Colour)” logo are trademarks of Sony Corporation.

“BRAVIA” is a trademark of Sony Corporation.

“PlayStation” is a registered trademark of Sony Computer Entertainment Inc.

“WALKMAN” is a registered trademark of Sony Corporation.

MICROVAULT is a trademark of Sony Corporation.

InstaPrevue™ is a trademark or registered trademark of Silicon Image, Inc. in the United States and other countries.

Table of Contents

About This Manual	5	Enjoying Sound Effects	
Supplied accessories	9	Selecting the sound field	42
Description and location of parts	10	Using the Night Mode function ...	45
Getting started	17	Selecting the calibration type	45
Connections		Adjusting the equalizer	45
1: Installing the speakers	19	Using the Pure Direct function	46
2: Connecting the speakers	20	Resetting sound fields to the default settings	46
3: Connecting the TV	21	“BRAVIA” Sync Features	
4a: Connecting the video equipment	22	What is “BRAVIA” Sync?	47
4b: Connecting the audio equipment	26	Preparing for the “BRAVIA” Sync	47
5: Connecting the antennas (aerials)	27	One-Touch Play	48
6: Connecting the AC power cord (mains lead)	27	System Audio Control	49
Preparing the Receiver		System Power-Off	49
Turning on the receiver	28	Scene Select	50
Setting up the receiver using the Easy Setup	28	Home Theatre Control	50
Guide to on-screen display (OSD) operation	30	Remote Easy Control	50
Basic Operations		Other Operations	
Playing an input source equipment	31	Switching between digital and analog audio (INPUT MODE)	51
Playing an iPod/iPhone	33	Using other audio input jacks (Audio Input Assign)	51
Playing a USB device	36	Reverting back to the factory default settings	52
Tuner Operations		Adjusting Settings	
Listening to FM/AM radio	39	Using the Settings menu	53
Presetting FM/AM radio stations (Preset Memory)	41	Easy Setup	55
Receiving RDS broadcasts (Europe and Australia models only)	41	Speaker Settings menu	55
		Audio Settings menu	58
		HDMI Settings menu	59
		Input Settings menu	60
		System Settings menu	61
		Operating without using the OSD	61

Using the Remote Control

Reassigning the input button	66
Resetting the input buttons	67

Additional Information

Precautions	68
Troubleshooting	69
Specifications	76
Index	78

Supplied accessories

- Operating Instructions (this manual)
- Quick Setup Guide (1)
- Remote control (RM-AAU168) (1)
- R6 (size AA) batteries (2)
- FM wire antenna (aerial) (1)



- AM loop antenna (aerial) (1)



- Optimizer microphone (ECM-AC2) (1)



Inserting batteries into the remote control

Insert two R6 (size-AA) batteries (supplied) in the remote control. Observe the correct polarity when installing batteries.

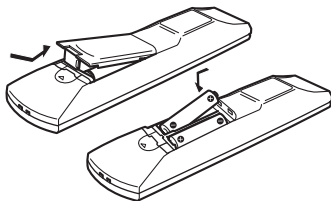

Notes

- Do not leave the remote control in an extremely hot or humid place.
- Do not use a new battery with old ones.
- Do not mix manganese batteries and other kinds of batteries.
- Do not expose the remote control sensor to direct sunlight or lighting apparatuses. Doing so may cause a malfunction.
- If you do not intend to use the remote control for an extended period of time, remove the batteries to avoid possible damage from battery leakage and corrosion.
- When you replace the batteries, the remote control buttons may be reset to their default settings. If this happens, reassign the input buttons (page 66).
- When the receiver no longer responds to the remote control, replace all the batteries with new ones.

Description and location of parts

Front panel

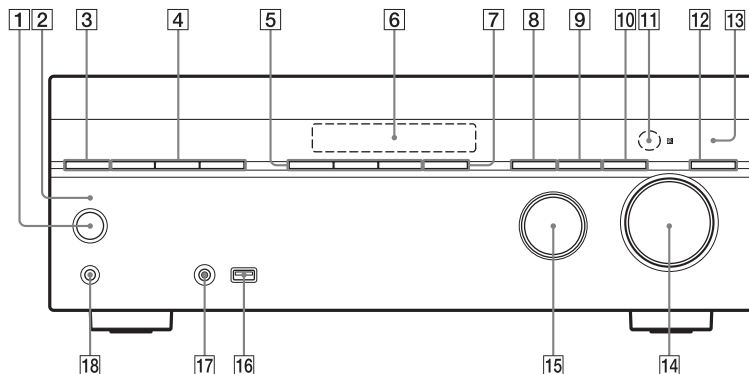

- 1** I/⏻ (on/standby) (page 28, 40, 46, 52)
- 2** I/⏻ (on/standby) indicator
Lights up as follows:
Green: The receiver is turned on.
Amber: The receiver is in standby mode, and
– “Control for HDMI” (page 59) is set to “On”.
– “Pass Through” (page 60) is set to “On”* or “Auto”.
Lights off when the receiver is in standby mode and “Control for HDMI” and “Pass Through” are set to “Off”.
* For USA, Canada and Australia models only.
- 3** **SPEAKERS** (page 20)
Press repeatedly to turn on or off the speaker system.
- 4** **TUNING MODE, TUNING +/-**
Press to operate a tuner (FM/AM).
Press TUNING +/- to scan a station.
- 5** **A.F.D./2CH, MOVIE, MUSIC** (page 42)
- 6** **Display panel** (page 11)
- 7** **NIGHT MODE** (page 45)
- 8** **INPUT MODE** (page 51)
- 9** **DIMMER**
Adjusts the brightness of the display panel in 3 levels.
- 10** **DISPLAY** (page 66)
- 11** **Remote control sensor**
Receives signals from remote control.
- 12** **PURE DIRECT** (page 46)
- 13** **PURE DIRECT indicator**
Lights up when Pure Direct function is activated.
- 14** **MASTER VOLUME** (page 32)
- 15** **INPUT SELECTOR** (page 29, 32, 51)
- 16** **ψ (USB) port** (page 26)
- 17** **AUTO CAL MIC jack** (page 29)
- 18** **PHONES jack**
Connects to headphones.

Indicators on the display panel

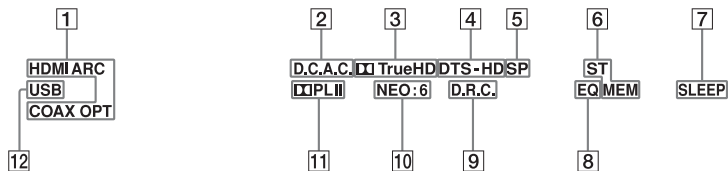

1 Input indicator

Lights up to indicate the current input.

HDMI

The receiver recognizes the equipment connected via an HDMI IN jack.

ARC

TV input is selected and the Audio Return Channel (ARC) signals are detected.

COAX

Digital signal is input through the COAXIAL jack (page 51).

OPT

Digital signal is input through the OPTICAL jack (page 51).

2 D.C.A.C.

Lights up when the measurement results of the “Auto Calibration” function are applied.

3 Dolby Digital Surround indicator*

Lights up the respective indicator when the receiver is decoding the corresponding Dolby Digital format signals.

Dolby Digital

TrueHD Dolby TrueHD

4 DTS(-HD) indicator*

Lights up the respective indicator when the receiver is decoding the corresponding DTS format signals.

DTS

DTS-HD

5 SP

Lights up when the speaker system is turned on.

6 Tuning indicator

ST

Lights up when the receiver tunes to a stereo broadcast.

MEM

Lights up when memory function, such as Preset Memory (page 41), etc., is activated.

7 SLEEP

Lights up when the Sleep Timer is activated (page 15).

8 EQ

Lights up when the equalizer is activated.

9 D.R.C.

Lights up when Dynamic Range Compression is activated (page 59).

10 NEO:6

Lights up when DTS Neo:6 Cinema/Music decoding is activated (page 43, 44).

11 Dolby Pro Logic indicator

Lights up the respective indicator when the receiver performs Dolby Pro Logic processing. This matrix surround decoding technology can enhance input signals.

PL Dolby Pro Logic

PL II Dolby Pro Logic II

Note

These indicators may not light up depending on the speaker pattern setting.

12 USB



Lights up when iPod/iPhone or USB device is detected.

* When playing a Dolby Digital or DTS format disc, make sure that you have completed the digital connections and that INPUT MODE is not set to "ANALOG" (page 51) or "Analog Direct" is not selected.

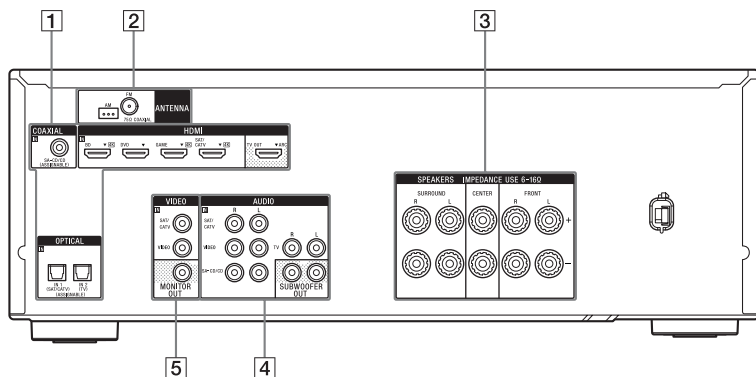

Rear panel



1 DIGITAL INPUT/OUTPUT section

-  HDMI IN/OUT* jacks (page 21, 24)
-  OPTICAL IN jacks (page 21, 25)
-  COAXIAL IN jack (page 26)



2 TUNER section

-  FM ANTENNA jack (page 27)
-  AM ANTENNA terminals (page 27)

3 SPEAKERS section (page 20)

-  +
-  -

4 AUDIO INPUT/OUTPUT section

-  White (L) AUDIO IN jacks (page 21, 25, 26)
-  Red (R)
-  Black SUBWOOFER OUT jacks (page 20)

5 VIDEO INPUT/OUTPUT section (page 21, 25)

-  Yellow VIDEO IN/OUT* jacks

* You must connect the HDMI TV OUT or MONITOR OUT jack to your TV to watch the selected input image (page 21).

Remote control

Use the supplied remote control to operate this receiver and other equipment. The remote control is assigned to operate Sony audio/video equipment. You can reassign the input button to match the equipment connected to your receiver (page 66).

RM-AAU168

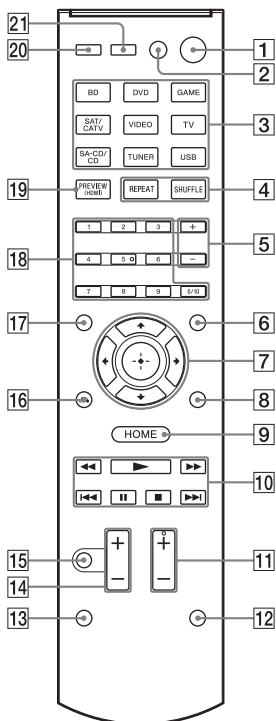

1 I/O (on/standby)

Turns the receiver on or sets it to the standby mode.

Saving the power in standby mode

When “Control for HDMI” (page 59) and “Pass Through” (page 60) are set to “Off”.

2 TV I/O¹⁾ (on/standby)

Turns the TV on or sets it to the standby mode.

3 Input buttons

Selects the equipment you want to use. When you press any of the input buttons during standby mode, the receiver turns on. The buttons are assigned to control Sony equipment.

4 TOP MENU¹⁾

Opens or closes the BD-ROM's or DVD's Top Menu.

REPEAT¹⁾

Plays a track or a folder repeatedly.

POP UP/MENU¹⁾

Opens or closes the BD-ROM's Pop-up Menu, or the DVD's menu.

SHUFFLE¹⁾

Plays a track or a folder in random order.

5 Folder +/-

Selects a folder.

6 AMP MENU

Displays the menu to operate the receiver.

7 (+¹⁾, up/down/left/right¹⁾

Press up/down/left/right to select the menu items, then press + to enter/confirm the selection.

8 OPTIONS¹⁾

Displays and selects items from the options menu.

9 HOME¹⁾

Displays the home menu on the TV screen.

10 I/O¹⁾, I/O¹⁾, I/O¹⁾, II¹⁾, ■¹⁾

Skip, backward/forward, play, pause, stop operation.

TUNING +/-¹⁾

Scans a station.

D.TUNING

Enters direct tuning mode.

PRESET +/-¹⁾

Selects preset stations or channels.

MEM

Stores a station during tuner operation.

11 SOUND FIELD +/-²⁾

Selects a sound field (page 42).

12 PURE DIRECT (page 46)

13 SLEEP

Sets the receiver to turn off automatically at a specified time. Each time you press SLEEP, the display changes cyclically as follows:

0:30:00 → 1:00:00 → 1:30:00 →
2:00:00 → OFF

When Sleep Timer is being used, "SLEEP" indicator lights up on the display panel.

Tip

To check the remaining time before the receiver turns off, press SLEEP. The remaining time appears on the display panel. If you press SLEEP again, the Sleep Timer will be canceled.

14 +/-

Adjusts the volume level of all speakers at the same time.

15

Turns off the sound temporarily. Press the button again to restore the sound.

16 RETURN ¹⁾

Returns to the previous menu while the menu or on-screen guide is displayed on the TV screen.

17 DISPLAY¹⁾

Views information on the display panel.

18 Numeric buttons¹⁾²⁾



Press to

- preset/tune to the preset stations (page 41).
- select track numbers. Press 0/10 to select track number 10.
- select channel numbers.

19 PREVIEW (HDMI)

Selects the "Preview for HDMI" function.

Turns on a live picture-in-picture preview of HDMI inputs connected to this receiver.

Press / repeatedly to select each HDMI input preview, then press  to enter/confirm the selection.

(This feature is powered by Silicon Image InstaPrevue™ technology)

Note

The "Preview for HDMI" function is available for HDMI BD, DVD, GAME and SAT/CATV input.

Tips

- This function does not work in the following cases.
 - The equipment is not connected to the HDMI input jack.
 - The equipment connected to the supported HDMI input jack is not turned on.
 - The current input is not HDMI input.
 - When "Fast View" is set to "Off".
 - When an unsupported HDMI video format (480i, 576i, 4K, some 3D video signal, some video camera signal or VGA signal) is input.
- The picture-in-picture preview will be blacked out when 4K or some 3D video signal is input.

iPhone CTRL

Enters iPod/iPhone control mode when using iPod/iPhone.

20 AMP

Activates the receiver operation.

21 TV INPUT¹⁾

Selects the input signal (TV input or video input).

¹⁾ See the table on page 16 for information on the buttons that you can use to control each equipment.

²⁾ The 5 and SOUND FIELD + buttons have tactile dots. Use the tactile dots as reference when operating the receiver.

Notes

- The above explanation is intended to serve as examples.
- Depending on the model of your connected equipment, some functions explained in this section may not work with the supplied remote control.

To control other Sony equipment

Name	TV	VCR	DVD player	Blu-ray Disc player	CD player
2 TV I/⏻	●				
4 TOP MENU, REPEAT			●	●	●
POP UP/MENU, SHUFFLE			●	●	●
7 ↕/↔/↔/↔, ⊕	●	●	●	●	
8 OPTIONS	●		●	●	
9 HOME	●	●	●	●	
10 ◀◀/PRESET -, ▶▶/PRESET +	●	●	●	●	●
◀◀/TUNING -, ▶▶/TUNING +	●	●	●	●	●
▶, II, ■	●	●	●	●	●
16 RETURN ↶	●		●	●	
17 DISPLAY	●	●	●	●	●
18 Numeric buttons	●	●	●	●	●
21 TV INPUT	●				

Getting started

You can enjoy your audio/video equipment connected to the receiver by following the simple steps below.

Before connecting cords, be sure to disconnect the AC power cord (mains lead).

Installing and connecting the speakers (page 19, 20)



Checking the connection appropriate for your equipment

Connecting the TV and video equipment (page 21, 22)

The image quality depends on the connecting jack. See the illustration below. Select the connection according to the jacks on your equipment.

We recommend that you connect your video equipment via HDMI connection if they have HDMI jacks.

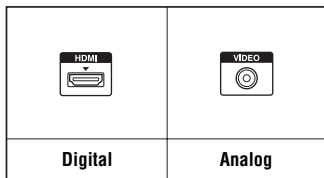

Connecting the audio equipment (page 26)



Preparing the receiver

See “6: Connecting the AC power cord (mains lead)” (page 27) and “Turning on the receiver” (page 28).



Setting the receiver

See “Setting up the receiver using the Easy Setup” (page 28).



Setting the audio output settings on the connected equipment

To output multi channel digital audio, check the digital audio output setting on the connected equipment.

For a Sony Blu-ray Disc player, check that “Audio (HDMI)”, “BD Audio MIX Setting”, “Dolby Digital/DTS”, “Dolby Digital”, and “DTS” are set to “Auto”, “Off”, “Bitstream”, “Dolby Digital”, and “DTS” respectively (as of August 1, 2012).

For a PlayStation 3, after having connected the receiver with an HDMI cable, select the “Audio Output Settings” in “Sound Settings”, and select “HDMI” and “Automatic” (with system software version 4.21).

For details, refer to the operating instructions supplied with the connected equipment.

Digital audio formats supported by the receiver

Digital audio formats that this receiver can decode depend on digital audio output jacks of the equipment connected. This receiver supports the following audio formats.

Audio format [Display]	Maximum number of channels	Connection between the playback equipment and the receiver	
		COAXIAL/OPTICAL	HDMI
Dolby Digital [DOLBY D]	5.1	○	○
Dolby Digital Plus ^{a)} [DOLBY D +]	7.1 ^{c)}	×	○
Dolby TrueHD ^{a)} [DOLBY HD]	7.1 ^{c)}	×	○
DTS [DTS]	5.1	○	○
DTS 96/24 [DTS 96/24]	5.1	○	○
DTS-HD High Resolution Audio ^{a)} [DTS-HD HR]	7.1 ^{c)}	×	○
DTS-HD Master Audio ^{a)b)} [DTS-HD MA]	7.1 ^{c)}	×	○
Multi Channel Linear PCM ^{a)} [PCM]	7.1 ^{c)}	×	○

a) Audio signals are output in another format if the playback equipment does not correspond to the format. For details, refer to the operating instructions of the playback equipment.

b) Signals with a sampling frequency of more than 96 kHz are played back at 96 kHz or 88.2 kHz.

c) The signals will be output as 5.1 channel.

1: Installing the speakers

This receiver allows you to use up to a 5.2 channel system (5 speakers and 2 subwoofers).

To fully enjoy theater-like multi channel surround sound requires five speakers (two front speakers, a center speaker, and two surround speakers) and a subwoofer.

Example of speaker system configuration

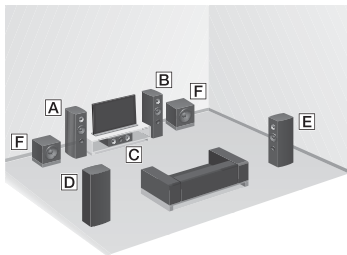

- A** Front speaker (Left)
- B** Front speaker (Right)
- C** Center speaker
- D** Surround speaker (Left)
- E** Surround speaker (Right)
- F** Subwoofer

Tips

- The angle **A** should be the same.

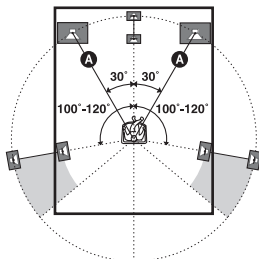

- Since the subwoofer does not emit highly directional signals, you can place it wherever you want.

2: Connecting the speakers

Before connecting cords, be sure to disconnect the AC power cord (mains lead).

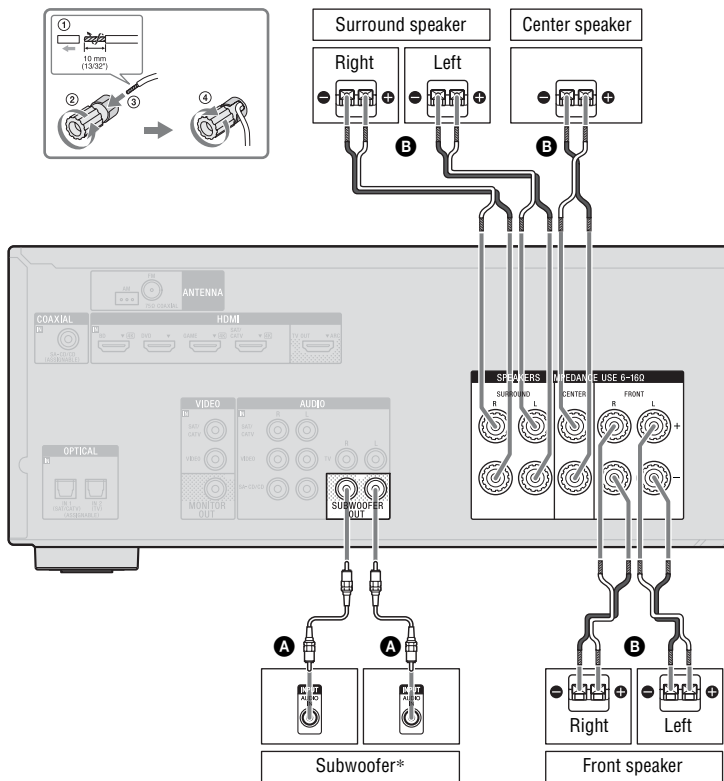

A Monaural audio cord (not supplied)

B Speaker cord (not supplied)

Note

You can turn on or off the speaker system with the **SPEAKERS** button (page 10).

* When you connect a subwoofer with an auto standby function, turn off the function when watching movies. If the auto standby function is set to on, it turns to standby mode automatically based on the level of the input signal to the subwoofer, and the sound may not be output.

3: Connecting the TV

You can watch the selected input image when you connect the HDMI TV OUT or MONITOR OUT jack to a TV. You can operate this receiver using an OSD (On-Screen Display) if you connect HDMI TV OUT jack to a TV.

Before connecting cords, be sure to disconnect the AC power cord (mains lead).

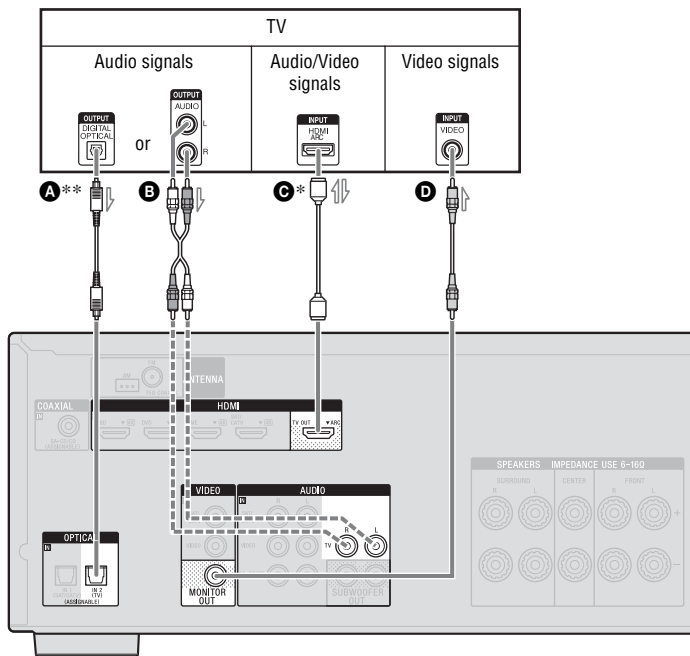

A Optical digital cord (not supplied)

B Audio cord (not supplied)

C HDMI cable (not supplied)

Sony recommends that you use an HDMI-authorized cable or Sony HDMI cable.

D Video cord (not supplied)

— Recommended connection

- - - Alternative connection

To enjoy the TV broadcast in multi channel surround sound from the receiver

- * If your TV is compatible with the Audio Return Channel (ARC) function, connect **④**. Be sure to set the “Control for HDMI” to “On” in HDMI Settings menu (page 59). If you want to select an audio signal using other than an HDMI cable (e.g., via an optical digital cord or an audio cord), switch the audio input mode using INPUT MODE (page 51).
- ** If your TV is not compatible with the ARC function, connect **⑤**.

Be sure to turn off the TV’s volume or activate the TV’s muting function.

Notes

- Connect a TV monitor or a projector to the HDMI TV OUT or MONITOR OUT jack on the receiver. You may not be able to record, even if you connect recording equipment.
- Depending on the status of the connection between the TV and the antenna (aerial), the image on the TV screen may be distorted. If this is the case, place the antenna (aerial) farther away from the receiver.
- When connecting optical digital cords, insert the plugs straight until they click into place.
- Do not bend or tie optical digital cords.

Tips

- All the digital audio jacks are compatible with 32 kHz, 44.1 kHz, 48 kHz, and 96 kHz sampling frequencies.
- When you connect the audio output jack of the TV to the TV IN jacks of the receiver to output the TV sound from the speakers connected to the receiver, set the sound output jack of the TV to “Fixed” if it can be switched between either “Fixed” or “Variable”.

To listen to the sound from the TV

If your TV does not support System Audio Control function, set the “HDMI Audio Out” to “TV+AMP” in the HDMI Settings menu (page 60).

4a: Connecting the video equipment

Using HDMI connection

High-Definition Multimedia Interface (HDMI) is an interface which transmits video and audio signals in digital format. By connecting Sony “BRAVIA” Sync-compatible equipment using HDMI cables, operations can be simplified. See ““BRAVIA” Sync Features” (page 47).

HDMI features

- A digital audio signals transmitted by HDMI can be output from the speakers connected to the receiver. This signal supports Dolby Digital, DTS, and Linear PCM. For details, see “Digital audio formats supported by the receiver” (page 18).
- The receiver can receive Multi Channel Linear PCM (up to 8 channels) with a sampling frequency of 192 kHz or less with an HDMI connection.
- This receiver supports High Bitrate Audio (DTS-HD Master Audio, Dolby TrueHD), Deep Color (Deep Colour), “x.v.Color (x.v.Colour)”, and 4K or 3D transmission.
- To enjoy 3D images, connect 3D-compatible TV and video equipment (Blu-ray Disc player, Blu-ray Disc recorder, PlayStation 3, etc.) to the receiver using High Speed HDMI cables, put on 3D glasses, and then play back a 3D-compatible content.
- To enjoy 4K (HDMI BD, GAME and SAT/CATV input) images, connect 4K-compatible TV and video equipment (Blu-ray Disc player, Blu-ray Disc recorder, etc.) to the receiver using High Speed HDMI cables, and then play back a 4K-compatible content.

- You can view HDMI BD, DVD, GAME and SAT/CATV input on picture-in-picture preview.

Notes on HDMI connections

- DSD signals of Super Audio CD are not input or output.
- Depending on the TV or the video equipment, 4K or 3D images may not be displayed.
- Refer to the operating instructions of each connected equipment for details.

When connecting cords

- Before connecting cords, be sure to disconnect the AC power cord (mains lead).
- It is not necessary to connect all the cords. Connect according to the availability of jacks on the connected equipment.
- Use a High Speed HDMI cable. If you use a Standard HDMI cable, 1080p, Deep Color (Deep Colour), 4K or 3D images may not be displayed properly.
- We do not recommend using an HDMI-DVI conversion cable. When you connect an HDMI-DVI conversion cable to a DVI-D equipment, the sound and/or the image may be lost. Connect a separate audio cords or digital connecting cords, then set the “Audio Input Assign” in the Input Settings menu (page 61) when the sound is not output correctly.
- When connecting optical digital cords, insert the plugs straight until they click into place.
- Do not bend or tie optical digital cords.

Tip

All the digital audio jacks are compatible with 32 kHz, 44.1 kHz, 48 kHz, and 96 kHz sampling frequencies.

If you want to connect several digital equipment, but cannot find an unused input

See “Using other audio input jacks (Audio Input Assign)” (page 51).

Connecting equipment with HDMI jacks

If your equipment does not have an HDMI jack, see page 25.

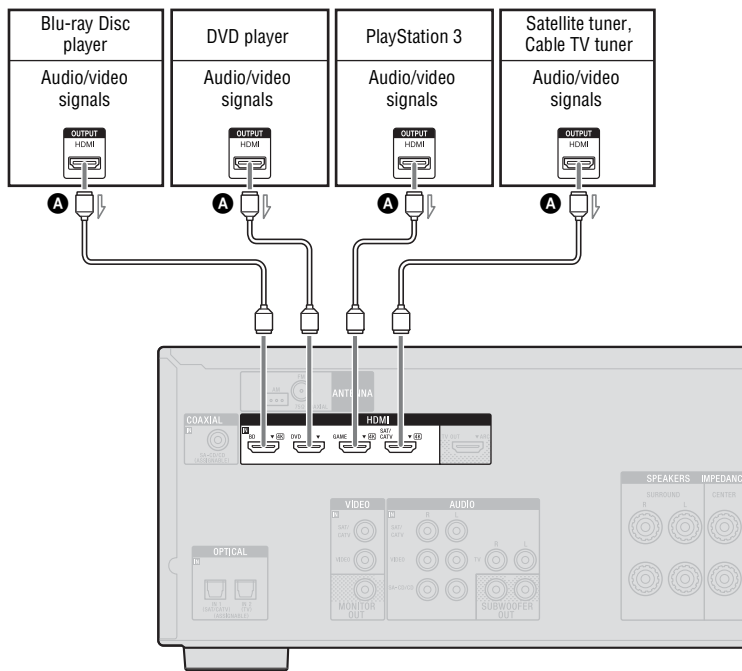

A HDMI cable (not supplied)

Sony recommends that you use an HDMI-authorized cable or Sony HDMI cable.

Connecting equipment with jacks other than HDMI jacks

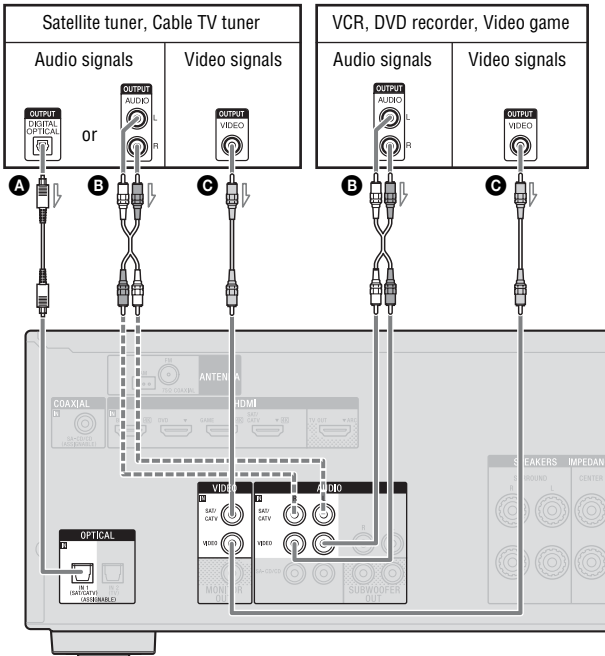

- A** Optical digital cord (not supplied)
- B** Audio cord (not supplied)
- C** Video cord (not supplied)

— Recommended connection
 - - - - Alternative connection

Note

Be sure to change the default setting of the VIDEO input button on the remote control so that you can use the button to control your DVD recorder. For details, see “Reassigning the input button” (page 66).

4b: Connecting the audio equipment

Connecting a Super Audio CD player, CD player

Before connecting cords, be sure to disconnect the AC power cord (mains lead).

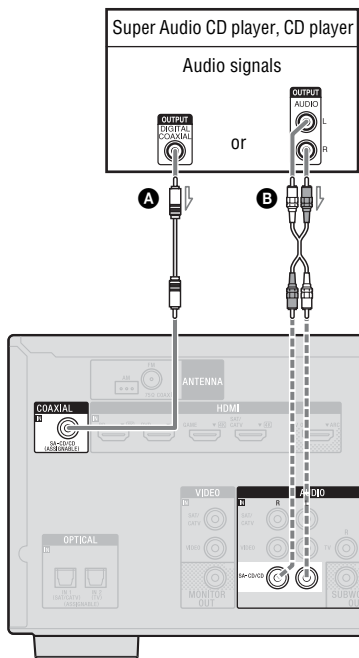

A Coaxial digital cord (not supplied)

B Audio cord (not supplied)

—— Recommended connection

----- Alternative connection

Connecting an iPod, iPhone, USB device

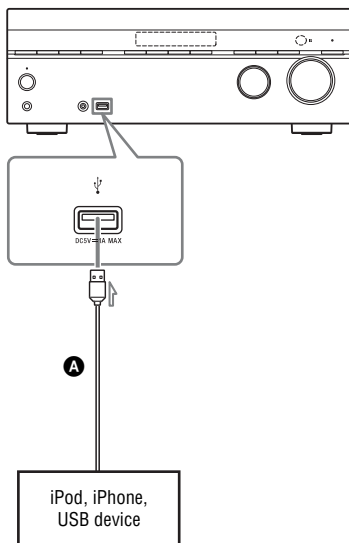

A USB cable (not supplied)

5: Connecting the antennas (aerials)

Before connecting the antennas (aerials), be sure to disconnect the AC power cord (mains lead).

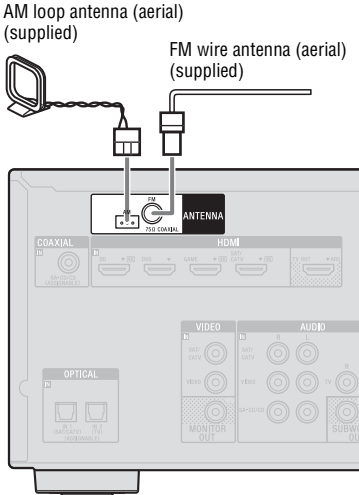

Notes

- To prevent noise pickup, keep the AM loop antenna (aerial) away from the receiver and other equipment.
- Be sure to fully extend the FM wire antenna (aerial).
- After connecting the FM wire antenna (aerial), keep it as horizontal as possible.

6: Connecting the AC power cord (mains lead)

Connect the AC power cord (mains lead) to a wall outlet.

AC power cord (mains lead)

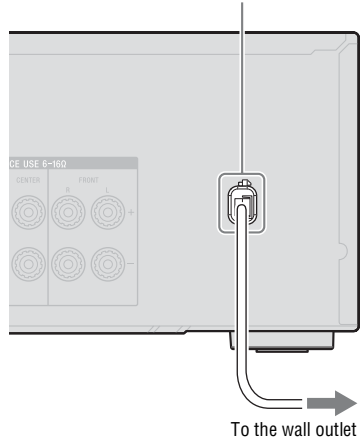

Preparing the Receiver

Turning on the receiver

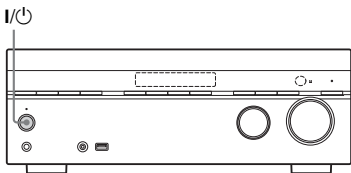

Press I/O to turn on the receiver.

You can also turn on the receiver using I/O on the remote control. When you turn off the receiver, press I/O again.

“STANDBY” flashes on the display panel. Do not disconnect the AC power cord (mains lead) while “STANDBY” is flashing. This may cause a malfunction.

Setting up the receiver using the Easy Setup

You can set the basic settings of the receiver easily by operating the receiver in accordance with the instructions on the TV screen.

Switch the input of the TV to the input to which the receiver is connected.

When you turn on the receiver for the first time or after the receiver is initialized, the Easy Setup screen appears on the TV screen. Proceed to set up the receiver in accordance with the instructions on the Easy Setup screen.

You can set up the following functions using the Easy Setup.

- Language
- Speaker Settings

Notes on Speaker Settings (Auto Calibration)

This receiver is equipped with DCAC (Digital Cinema Auto Calibration) function which allows you to perform automatic calibration as follows:

- Check the connection between each speaker and the receiver.
- Adjust the speaker level.
- Measure the distance of each speaker from your seating position.*
- Measure the speaker size.*
- Measure the frequency characteristics (EQ).*

* The measurement result is not utilized when “Analog Direct” is selected.

The DCAC is designed to achieve proper sound balance for your room. However, you can adjust the speaker levels manually according to your preference. For details, see “Test Tone” (page 58).

Before you perform Auto Calibration

Before you perform Auto Calibration, check the following items.

- Set up and connect the speakers (page 19, 20).
- Connect only the supplied optimizer microphone to the AUTO CAL MIC jack. Do not connect any other microphones to this jack.
- Make sure the speaker output is not set to “SPK OFF” (page 10).
- Disconnect the headphones.
- Remove any obstacles in the path between the optimizer microphone and the speakers to avoid measurement errors.
- Get accurate measurement by making sure the environment is free from noise and quiet.

Notes

- The speakers emit very loud sound during the calibration and the volume cannot be adjusted. Provide consideration to your neighborhood and to the children in presence.
- If the muting function has been activated before you perform Auto Calibration, the muting function will shut off automatically.
- The correct measurements may not be able to take or Auto Calibration cannot be performed when special speakers, such as dipole speakers are used.

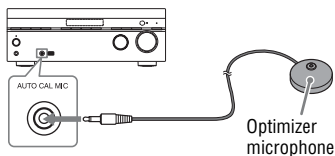
To set up the Auto Calibration

- 1 Connect the supplied optimizer microphone to the AUTO CAL MIC jack.
- 2 Set up the optimizer microphone.
Place the optimizer microphone at your seating position and set it at the same height as your ears.

Confirm active subwoofer setup

- When a subwoofer is connected, turn on the subwoofer and turn up the volume prior to activating the subwoofer. Turn the LEVEL to just before the mid-point.
- If you connect a subwoofer with a crossover frequency function, set the value to maximum.
- If you connect a subwoofer with an auto standby function, set it to off (deactivated).

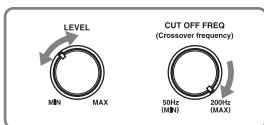
**Note**

Depending on the characteristics of the subwoofer you are using, the setup distance value may be different from the actual position.

When you connect two subwoofers to the receiver

If you cannot obtain measurement results of the “Auto Calibration” function correctly, depending on the environment, or you want to make fine adjustments, you can set up the subwoofers manually. For details, see “Manual Setup” in the Speaker Settings menu (page 56).

To cancel Auto Calibration

The Auto Calibration function will be canceled when you perform the following during the measurement process:

- Press I/⏻.
- Press the input buttons on the remote control or turn the INPUT SELECTOR on the receiver.
- Press .
- Press SPEAKERS on the receiver.
- Change the volume level.
- Connect the headphones.

To set up the receiver manually

See “Adjusting Settings” (page 53).

Guide to on-screen display (OSD) operation

You can display the menu of the receiver on the TV screen and select the function you want to use on the TV screen by pressing $\uparrow/\downarrow/\leftarrow/\rightarrow$ and \oplus on the remote control.

When you start operating the receiver, make sure to press AMP on the remote control first. Otherwise, operations that follow may not be aimed at the receiver.

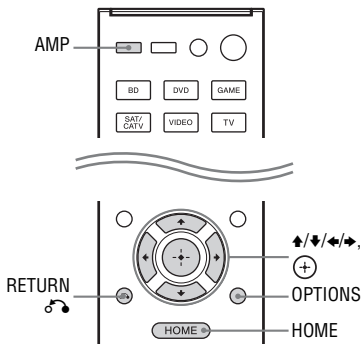

Using the menu

- 1 Switch the input of the TV to the input which the receiver is connected.**
- 2 Press AMP, then press HOME.**

The home menu is displayed on the TV screen.

Depending on the TV, the home menu may take some time to appear on the TV screen.

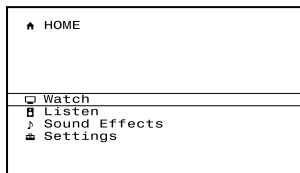

- 3 Press \uparrow/\downarrow repeatedly to select a menu you want, then press \oplus to enter the menu.**

The menu item list appears on the TV screen.

Example: When you select "Watch".

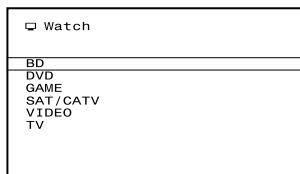

- 4 Press \uparrow/\downarrow repeatedly to select the menu item you want to adjust, then press \oplus to enter the menu item.**

Tip

When "OPTIONS" appears in the lower right portion of the OSD, you can display the function list by pressing OPTIONS and selecting a related function.

To return to the previous screen

Press RETURN \curvearrowright .

To exit the menu

Press HOME to display the home menu, then press HOME again.

Overview of the home menus

Menu	Description
Watch	Selects the video source to be input to the receiver (page 31).
Listen	Selects the music source to be input to the receiver (page 31). You can also enjoy FM/AM radio of the built-in receiver (page 39).
Sound Effects	Enables you to enjoy sound development provided by various Sony proprietary technologies or functions (page 42).
Settings	Adjusts the settings of the receiver (page 53).

Basic Operations

Playing an input source equipment

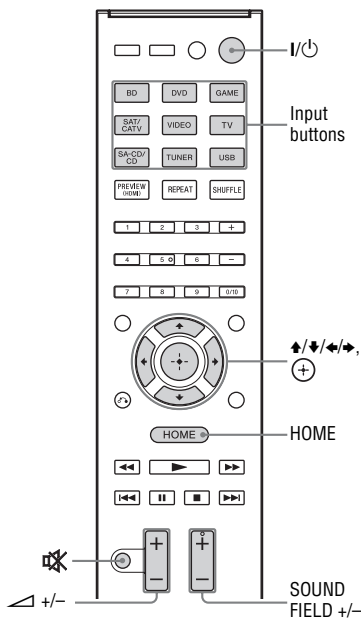

- 1 Press HOME.**
The home menu is displayed on the TV screen.
- 2 Select “Watch” or “Listen”, then press **+**.**
The menu item list appears on the TV screen.
- 3 Select the equipment you want, then press **+**.**
- 4 Turn on the equipment and start playback.**

5 Press +/- to adjust the volume.

You can also use MASTER VOLUME on the receiver.

6 Press SOUND FIELD +/- to enjoy the surround sound.

You can also use A.F.D./2CH, MOVIE or MUSIC on the receiver. For details, see page 42.

Tips

- You can turn INPUT SELECTOR on the receiver or press input buttons on the remote control to select the equipment you want.
- You can adjust the volume differently using the MASTER VOLUME knob on the receiver or the +/- button on the remote control.
 - To turn the volume up or down quickly
 - Turn the knob quickly.
 - Press and hold the button.
 - To make fine adjustment
 - Turn the knob slowly.
 - Press the button and release it immediately.

To activate the muting function

Press .

The muting function will be canceled when you do the following.

- Press again.
- Change the volume.
- Turn off the receiver.
- Perform Auto Calibration.

To avoid damaging your speakers

Before you turn off the receiver, be sure to turn down the volume level.

Playing an iPod/iPhone

You can enjoy music contents from the iPod/iPhone by connecting it to the ψ (USB) port on the receiver.

For details on connecting the iPod/iPhone, see page 26.

Compatible iPod/iPhone models

You can use the following iPod/iPhone models on this receiver. Update your iPod/iPhone with the latest software before using it.



iPod touch
4th generation



iPod touch
3rd generation



iPod touch
2nd generation



iPod nano
6th generation



iPod nano
5th generation
(video camera)



iPod nano
4th generation
(video)



iPod nano
3rd generation
(video)



iPod classic



iPhone 4S



iPhone 4



iPhone 3GS



iPhone 3G

Notes

- Sony cannot accept responsibility in the event that data recorded to iPod/iPhone is lost or damaged when using an iPod/iPhone connected to this receiver.
- This product has been designed specifically to work with iPod/iPhone and has been certified to meet Apple performance standards.

Selecting the iPod/iPhone control mode

You can select the iPod/iPhone control mode using the OSD menu or iPhone CTRL on the remote control.

You can use the OSD menu to browse contents on the iPod/iPhone.

You can also control all operations by viewing the information on the display panel when TV screen is turned off.

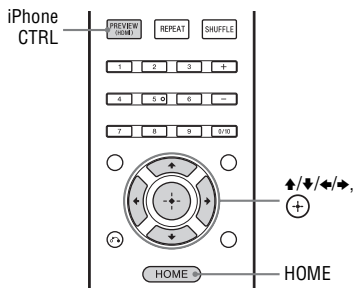

- 1 Press HOME.**
The home menu is displayed on the TV screen.
- 2 Select "Listen", then press (+).**
- 3 Select "USB", then press (+).**
When the iPod or iPhone is connected, "iPod/iPhone" appears on the TV screen.
- 4 Select "System OSD" or "iPod/iPhone", then press (+).**

Operating the iPod/iPhone using "System OSD" mode

- 1 Make sure that "System OSD" is selected in step 4 in "Selecting the iPod/iPhone control mode" (page 34).**
- 2 Select the content you want from the content list, then press (+).**
The selected content starts playback and the information of music contents appears on the TV screen.

To select the playback mode

You can change the playback mode using the OPTIONS on the remote control.

- Repeat: Off / One / All
- Shuffle: Off / Songs / Albums
- Audiobooks: Slower / Normal / Faster

Operating the iPod/iPhone using "iPod/iPhone" mode

- 1 Make sure that "iPod/iPhone" is selected in step 4 in "Selecting the iPod/iPhone control mode" (page 34).**
- 2 Select the content you want using iPod/iPhone menu.**
For details on operating the iPod/iPhone, refer to the operating instructions supplied with iPod/iPhone.

To operate the iPod/iPhone using the remote control

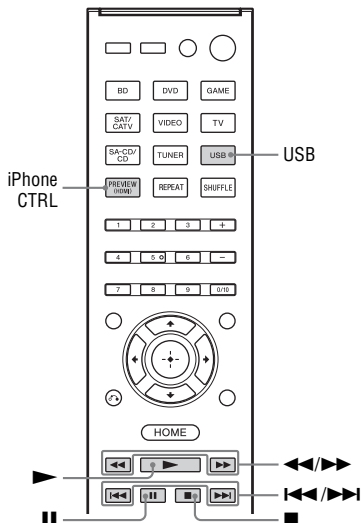

Press USB before you use the following buttons.

Press	Operation
▶	Starts play.
⏸, ■	Pauses play.
⏮/⏭	Fast reverses or forwards.
⏪/⏩	Goes to the previous/next track.
iPhone CTRL	Selects the iPod/iPhone control mode.

Notes on iPod/iPhone

- The iPod/iPhone is charged when connected to the receiver while the receiver is turned on.
- You cannot transfer songs onto the iPod/iPhone from this receiver.
- Do not remove the iPod/iPhone during operation. To avoid data corruption or damage to the iPod/iPhone, turn the receiver off when connecting or removing the iPod/iPhone.

iPod/iPhone message list

Message and explanation

Reading

The receiver is recognizing and reading information of the iPod or iPhone.

Loading

The receiver is loading information of the iPod or iPhone.

Not supported

An unsupported iPod or iPhone is connected.

No device is connected

No iPod or iPhone is connected.

No music

No music was found.

Headphones not supported

No sound is output from the headphones when iPod or iPhone is connected.

Playing a USB device

You can enjoy music from the USB device by connecting it to the Ψ (USB) port on the receiver.

For details on connecting a USB device, see “Connecting an iPod, iPhone, USB device” (page 26).

The music file formats that can be played back by this receiver are as follows:

File format	Extensions
MP3 (MPEG-1 Audio Layer III)	“.mp3”
AAC*	“.m4a”, “.3gp”, “.mp4”
WMA9 Standard*	“.wma”
WAV	“.wav”

* The receiver does not play files encoded with DRM.

Compatible USB devices

You can use the following Sony USB devices on this receiver.

Verified Sony USB device

Product name	Model name
Walkman®	NWZ-S754 / S755
	NWZ-E453 / E454 / E455
	NWZ-E353 / E354 / E355
	NWZ-B133 / B135 / B133F / B135F
	NWZ-B142 / B143 / B142F / B143F
	NWD-E023F / E025F
	NWZ-E435F / E436F / E438F
	NWZ-E343 / E344 / E345

Product name	Model name
	NWZ-S636F / S638F / S639F
	NWZ-S736F / S738F / S739F
	NWZ-A726 / A728 / A729 / A726B / A728B
	NWZ-A826 / A828 / A829
	NWZ-W202
	NWZ-X1050 / X1060
	NWZ-S744 / S745
	NWZ-E443 / E444 / E445
	NWZ-S543 / S544 / S545
	NWZ-A844 / A845 / A846 / A847
	NWZ-W252 / W253
	NWZ-B152 / B153 / B152F / B153F
MICROVAULT	USM1GL / 2GL / 4GL / 8GL / 16GL
	USM1GLX / 2GLX / 4GLX / 8GLX / 16GLX

Notes

- The receiver is unable to read data in NTFS format.
- The receiver is unable to read data other than that saved in the first partition of a hard disk drive.
- Operation of models not listed here is not guaranteed.
- Operation may not always be ensured even when using these USB devices.
- Some of these USB devices may not be available for purchase in certain areas.
- When formatting the above models, be sure to format using the model itself or the dedicated formatting software for that model.
- When connecting a USB device to the receiver, be sure to connect after the display “Creating Library” or “Creating Database” on the USB device has disappeared.

Operating the USB device

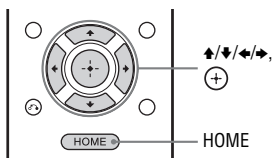

- 1 Press HOME.**
The home menu is displayed on the TV screen.
- 2 Select “Listen”, then press (+).**
When the USB device is connected, “USB” appears on the TV screen.
- 3 Select “USB”, then press (+).**
You can operate the USB device using the remote control of the receiver. The information of music contents appear on the TV screen.

To operate the USB device using the remote control

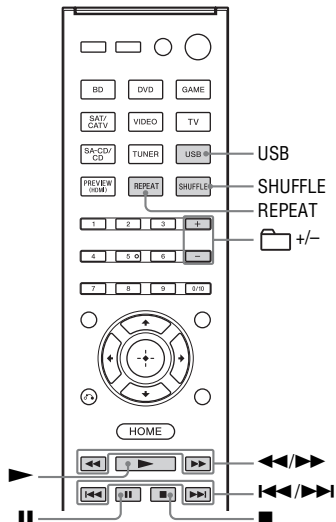

Press USB before you use the following buttons.

Press	Operation
	Starts play.
	Pauses play.
	Stops play.
	Fast reverses or forwards.
	Goes to the previous/next file.
	Goes to the previous/next folder.
REPEAT*	Enters repeat mode (Off / One / All / Folder).
SHUFFLE*	Enters shuffle mode (Off / All / Folder).

* Press repeatedly to select the playback mode.

Notes on the USB device

- Do not remove the USB device during operation. To avoid data corruption or damage to the USB device, turn the receiver off when connecting or removing the USB device.
- Do not connect the receiver and the USB device through a USB hub.
- It may take about 10 seconds before “Reading” appears depending on the type of USB device connected.
- When the USB device is connected, the receiver reads all the files on the USB device. If there are many folders or files on the USB device, it may take a long time to finish reading the USB device.
- The receiver can recognize up to
 - 256 folders (including “ROOT” folder).
 - 256 audio files for each folder.
 - 8 folder levels (tree structure of files, including “ROOT” folder).

The maximum number of audio files and folders may vary depending on the file and folder structure.

Do not save other types of files or unnecessary folders on a USB device.

- Compatibility with all encoding/writing softwares, recording devices, and recording media cannot be guaranteed. Incompatible USB device may produce noise or interrupted audio or may not play at all.
- Some time may be needed to start playback when:
 - the folder structure is complex.
 - the memory capacity is excessive.
- This receiver does not necessarily support all the functions provided in a connected USB device.
- The playback order for the receiver may differ from the playback order of the connected USB device.
- Folders that have no audio files are skipped.
- When playing a very long track, some operations may cause playback delay.

USB message list

Message and explanation

Reading

The receiver is recognizing and reading information of the USB device.

Device error

The memory of the USB device could not be recognized (page 36).

Not supported

An unsupported USB device is connected, an unknown device is connected, or the USB device is connected through a USB hub (page 36).

No device is connected

No USB device is connected or the connected USB device is not recognized.

No track

No track was found.

Tuner Operations

Listening to FM/AM radio

You can listen to FM and AM broadcasts through the built-in tuner. Before operation, be sure you have connected the FM and AM antennas (aerials) to the receiver (page 27).

Tip

The tuning scale for direct tuning is shown below.

Area	FM	AM
USA, Canada	100 kHz	10 kHz*
Europe, Australia	50 kHz	9 kHz

* The AM tuning scale can be changed (page 40).

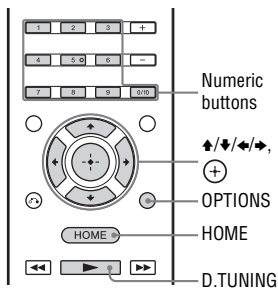

- 1 Select "Listen" from the home menu, then press (+).
- 2 Select "FM" or "AM" from the menu, then press (+).
The FM or AM menu list appears on the TV screen.

FM/AM screen

You can select and operate each item on the screen by pressing $\uparrow/\downarrow/\leftarrow/\rightarrow$ and (+).

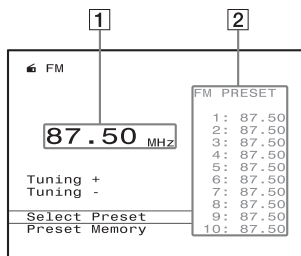

- 1 Frequency indication (page 40)
- 2 Preset station list (page 41)

Tuning to a station automatically (Auto Tuning)

Select "Tuning +" or "Tuning -", then press (+).

Select "Tuning +" to scan from lower to higher frequency stations, select "Tuning -" to scan from higher to lower stations.

The receiver stops scanning whenever a station is received.

In case of poor FM stereo reception

- 1 Tune in the station you want to listen to using Auto Tuning, Direct Tuning (page 40), or select the preset station you want (page 41).
- 2 Press OPTIONS.
- 3 Select "FM Mode", then press (+).
- 4 Select "Mono", then press (+).

Tuning to a station directly (Direct Tuning)

You can enter the frequency of a station directly by using the numeric buttons.

- 1 Press **D.TUNING**.
- 2 Press the numeric buttons to enter the frequency, then press **+**.

Example 1: FM 102.50 MHz

Select 1 → 0 → 2 → 5 (→ 0*)

Example 2: AM 1,350 kHz

Select 1 → 3 → 5 → 0

* Press 0 for Europe and Australia models only.

Tip

Adjust the direction of the AM loop antenna (aerial) for optimum reception upon tuning to an AM station.

If you cannot tune to a station

“----.--- MHz” or “---- kHz” appears and then the screen returns to the current frequency.

Make sure you have entered the right frequency. If not, repeat steps 1 to 3. If you still cannot tune to a station, the frequency may not be in use in your area.

Changing the AM tuning scale

(USA and Canada models only)

You can change the AM tuning scale to either 9 kHz or 10 kHz using the buttons on the receiver.

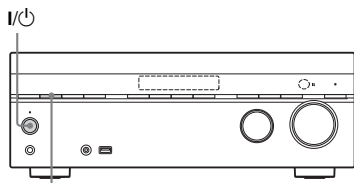

TUNING MODE

- 1 Press **I/⏻** to turn off the receiver.
- 2 While holding down **TUNING MODE**, press **I/⏻** on the receiver.

The current AM tuning scale is changed to 9 kHz (or 10 kHz).

To reset the scale to 10 kHz (or 9 kHz), repeat the procedure above.

Notes

- Depending on the settings, the receiver may take some time to change the AM tuning scale.
- All preset stations will be erased when you change the tuning scale.

Presetting FM/AM radio stations (Preset Memory)

You can store up to 30 FM and 30 AM stations as your favorite stations.

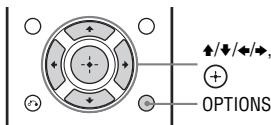

- 1** Tune to the station that you want to preset using Auto Tuning (page 39) or Direct Tuning (page 40).
- 2** Select “Preset Memory”, then press **+**.
- 3** Select a preset number, then press **+**.
The station is stored as the selected preset number.
- 4** Repeat steps 1 to 3 to store another station.
You can store station as follows:
 - AM band: AM 1 to AM 30
 - FM band: FM 1 to FM 30

Tuning to preset stations

- 1** Select “FM” or “AM” from the menu, then press **+**.
- 2** Select “Select Preset”, then press **+**.
- 3** Select the preset station you want, then press **+**.
Preset numbers from 1 to 30 are available.

Naming preset stations (Name Input)

- 1** Select “FM” or “AM” from the menu, then press **+**.
- 2** Select “Select Preset”, then press **+**.
- 3** Select the preset number which you want to name, press **+**, then press **OPTIONS**.
- 4** Select “Name Input”, then press **+**.
- 5** Press **↔** repeatedly to select a character, then press **→**.
You can move the input position backward and forward by pressing **↔**. You can enter a name up to 8 characters.
- 6** Repeat step 5 to input a character one by one, then press **+**.
The name you entered is registered.

Receiving RDS broadcasts

(Europe and Australia models only)

This receiver allows you to use Radio Data System (RDS), which enables radio stations to send additional information along with the regular programming signal. This receiver offers convenient RDS features, such as Program Service name display. RDS is available only for FM stations.*

* Not all FM stations provide RDS service, nor do they provide the same type of services. If you are not familiar with the RDS services in your area, check with your local radio stations for details.

Simply select a station on the FM band.

When you tune to a station that provides RDS services, the Program Service name* appears on the TV screen and the display panel.

* If an RDS broadcast is not received, a Program Service name will not appear.

Notes

- RDS may not work properly if the station you tuned to is not transmitting the RDS signal or if the signal strength is weak.
- Some letters that can be displayed on the TV screen cannot be displayed on the display panel.

Tip

While a Program Service name is displayed, you can check the frequency by pressing DISPLAY repeatedly (page 66).

Enjoying Sound Effects

Selecting the sound field

This receiver can create multi channel surround sound. You can select one of the optimized sound fields from the receiver's pre-programmed sound fields.

- 1** Select "Sound Effects" from the home menu, then press (+).
- 2** Select "Sound Field", then press (+).
- 3** Select the sound field you want.

Tips

- You can press SOUND FIELD +/- on the remote control repeatedly to select the sound field you want.
- You can also use A.F.D./2CH, MOVIE or MUSIC on the receiver.

Auto Format Direct (A.F.D.)/2 channel sound mode

- **Auto Format Direct (A.F.D.) mode:** This mode allows you to listen to higher fidelity sound and select the decoding mode for listening to a 2 channel stereo sound as multi channel sound.
- **2 channel sound mode:** You can switch the output sound to 2 channel sound regardless of the recording formats of the software you are using, the playback equipment connected, or the sound field settings of the receiver.

■ A.F.D. Auto (A.F.D. AUTO)

Presets the sound as it was recorded/ encoded without adding any surround effects.

However, for USA and Canada models, this receiver will generate a low frequency signal for output to the subwoofer when there is no LFE signals.

■ Multi Stereo (MULTI ST.)

Outputs 2 channel left/right signals from all speakers. However, sound may not be output from certain speakers depending on the speaker settings.

■ 2ch Stereo (2CH ST.)

The receiver outputs the sound from the front left/right speakers only. There is no sound from the subwoofer. Standard 2 channel stereo sources completely bypass the sound field processing and multi channel surround formats are downmixed to 2 channels.

■ Analog Direct (A. DIRECT)

You can switch the audio of the selected input to 2 channel analog input. This function enables you to enjoy high quality analog sources.

When using this function, only the volume and front speaker level can be adjusted.

Note

You cannot select "Analog Direct" when you select BD, DVD, GAME and USB as input.

Movie mode

You can take advantage of surround sound simply by selecting one of the receiver's pre-programmed sound fields. They bring the exciting and powerful sound of movie theaters into your home.

■ HD-D.C.S.

HD Digital Cinema Sound (HD-D.C.S.) is Sony's new innovative home theater technology using the latest acoustic and digital signal processing technologies. It is based on precise response measurement data of a mastering studio.

With this mode, you are able to enjoy Blu-ray and DVD movies at home with not only the high quality of sound, but also the best sound ambience, just as the movie's sound engineer intended in the mastering process. You can select the effect type for HD-D.C.S. as follows.

- **Dynamic:** This setting is suitable for an environment which is reverberant but lacks a spacious feeling (where sound absorption is not sufficient). It emphasizes the reflection of sound and reproduces the sound of a large, classical movie theater. Thus, the spacious feeling of a dubbing theater is emphasized and a unique acoustic field is created.
- **Theater:** This setting is suitable for a general living room. It reproduces the reverberation of sound just like in a movie theater (dubbing theater). It is most appropriate for watching content recorded on a Blu-ray Disc when you want the atmosphere of a movie theater.
- **Studio:** This setting is suitable for a living room with the appropriate sound equipment. It reproduces the reverberation of sound provided when a theatrical sound source is remixed for a Blu-ray Disc to a volume level suitable for home use. The level of reflection and reverberation of sound is kept to the minimum. However, dialogues and surround effects are reproduced vividly.

■ PLII Movie

Performs Dolby Pro Logic II Movie mode decoding. This setting is ideal for movies encoded in Dolby Surround. In addition, this mode can reproduce sound in 5.1 channel for watching videos of overdubbed or old movies.

■ Neo:6 Cinema (Neo:6 CIN)

Performs DTS Neo:6 Cinema mode decoding. A source recorded in 2 channel format is decoded into 5 channels.

Music mode

You can take advantage of surround sound simply by selecting one of the receiver's pre-programmed sound fields. They bring the exciting and powerful sound of concert halls into your home.

■ Hall (HALL)

Reproduces the acoustics of a classical concert hall.

■ Jazz Club (JAZZ)

Reproduces the acoustics of a jazz club.

■ Live Concert (CONCERT)

Reproduces the acoustics of a 300-seat live house.

■ Stadium (STADIUM)

Reproduces the feeling of a large open-air stadium.

■ Sports (SPORTS)

Reproduces the feeling of sports broadcasting.

■ Portable Audio (PORTABLE)

Reproduces a clear enhanced sound image from your portable audio device. This mode is ideal for MP3 and other compressed music.

■ PLII Music

Performs Dolby Pro Logic II Music mode decoding. This setting is ideal for normal stereo sources such as CDs.

■ Neo:6 Music (Neo:6 MUS)

Performs DTS Neo:6 Music mode decoding. A source recorded in 2 channel format is decoded into 5 channels. This setting is ideal for normal stereo sources such as CDs.

When headphones are connected

You can only select this sound field if the headphones are connected to the receiver.

■ HP 2CH

This mode is selected automatically if you use headphones (except "Analog Direct"). Standard 2 channel stereo sources completely bypass the sound field processing and multi channel surround formats are downmixed to 2 channels except LFE signals.

■ HP Direct (HP DIRECT)

This mode is selected automatically if you use headphones when "Analog Direct" is selected.

Outputs the analog signals without processing by the equalizer, sound field, etc.

If you connect a subwoofer

This receiver will generate a low frequency signal for output to the subwoofer when there is no LFE signal, which is a low-pass sound effect output from a subwoofer to a 2 channel signal. However, the low frequency signal is not generated for "Neo:6 Cinema" or "Neo:6 Music" when all speakers are set to "Large". In order to take full advantage of the Dolby Digital bass redirection circuitry, we recommend setting the subwoofer's cut off frequency as high as possible.

Notes on sound fields

- Depending on the speaker pattern settings, some sound fields may not be available.

- The sound fields for music and movie do not work in the following cases.
 - DTS-HD Master Audio, DTS-HD High Resolution Audio or Dolby TrueHD with sampling frequency of more than 48 kHz are being received.
 - “Analog Direct” is selected.
- “PLII Movie”, “PLII Music”, “Neo:6 Cinema” and “Neo:6 Music” do not work when the speaker pattern is set to 2/0 or 2/0.1.
- When one of the sound fields for music is selected, no sound is output from the subwoofer if all the speakers are set to “Large” in the Speaker Settings menu. However, the sound will be output from the subwoofer if
 - the digital input signal contains LFE signals.
 - the front or surround speakers are set to “Small”.
 - “Multi Stereo”, “PLII Movie”, “PLII Music”, “HD-D.C.S.” or “Portable Audio” is selected.

Using the Night Mode function

This function allows you to retain a theater-like environment at low volume levels. When watching a movie late at night, you will be able to hear the dialog clearly even at a low volume level. This function can be used with other sound fields.

- 1** Select “Sound Effects” from the home menu, then press \oplus .
- 2** Select “Night Mode”, then press \oplus .
- 3** Select “On” or “Off”, then press \oplus .

Note

This function does not work when “Analog Direct” is selected.

Tips

- You can also set the Night Mode function on and off by using NIGHT MODE on the receiver (page 10).
- While the Night Mode is turned on, the bass, treble, and effect levels increase, and “D.Range Comp.” is automatically set to “On”.

Selecting the calibration type

You can select the calibration type you want after performing the Auto Calibration. For details, see “Calibration Type” (page 56).

Adjusting the equalizer

You can use the following parameters to adjust the tonal quality (bass/treble level) of front speakers.

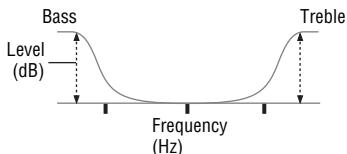

- 1** Select “Sound Effects” from the home menu, then press \oplus .
- 2** Select “Equalizer”, then press \oplus .
- 3** Select the gain of “Bass” or “Treble”, then press \oplus .
- 4** Adjust the gain, then press \oplus .

Notes

- This function does not work when “Analog Direct” is being used.
- Frequencies for Bass and Treble are fixed.
- Depending on the audio format, the receiver may play back signals at a lower sampling frequency than the original sampling frequency of the input signals.

Using the Pure Direct function

The Pure Direct mode lets you enjoy higher fidelity sound. When Pure Direct is on, the display panel lights off to suppress the noise that affects sound quality. You can use the Pure Direct function with all inputs.

- 1** Select “Sound Effects” from the home menu, then press (+).
- 2** Select “Pure Direct”, then press (+).
- 3** Select “On” or “Off”, then press (+).

Note

When Pure Direct function is selected, “Equalizer”, “Night Mode”, “Auto Volume” and “D.Range Comp.” do not work.

Tip

You can also use PURE DIRECT button on the remote control or receiver to turn on or off the Pure Direct function.

To cancel Pure Direct

The Pure Direct function will be canceled when you perform the following:

- Press PURE DIRECT again.
- Change the sound field.
- Change the scene setting on the TV (Scene Select).
- Change the setting of “Equalizer”, “Night Mode”, “Auto Volume” or “D.Range Comp.”.

Resetting sound fields to the default settings

Be sure to use the buttons on the receiver to perform this operation.

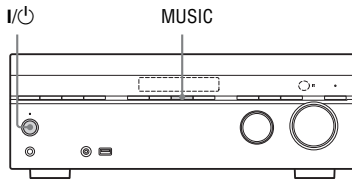

- 1** Press I/⏻ to turn off the receiver.
- 2** While holding down MUSIC, press I/⏻.

“S.F. CLEAR” appears on the display panel and all sound fields are reset to their default setting.

What is “BRAVIA” Sync?

The “BRAVIA” Sync function allows communication between Sony products such as TV, Blu-ray Disc player, DVD player, AV amplifier, etc. that supports the Control for HDMI function.

By connecting Sony equipment that is compatible with the “BRAVIA” Sync with an HDMI cable (not supplied), operation is simplified as follows:

- One-Touch Play (page 48)
- System Audio Control (page 49)
- System Power-Off (page 49)
- Scene Select (page 50)
- Home Theatre Control (page 50)
- Remote Easy Control (page 50)

Control for HDMI is a mutual control function standard used by HDMI CEC (Consumer Electronics Control) for HDMI (High-Definition Multimedia Interface).

We recommend that you connect the receiver to products featuring “BRAVIA” Sync.

Notes

- You may use “One Touch Play”, “System Audio Control”, and “System Power-Off” function with non-Sony equipment. However, compatibility with all non-Sony equipment is not guaranteed.
- “Scene Select” and “Home Theatre Control” features are Sony proprietary functions. They cannot operate with non-Sony equipment.
- Equipment not compatible with “BRAVIA” Sync cannot activate these features.

Preparing for the “BRAVIA” Sync

The receiver is compatible with the “Control for HDMI-Easy Setting” function.

- If your TV is compatible with the “Control for HDMI-Easy Setting” function, you can set the Control for HDMI function of the receiver and playback equipment automatically by setting the Control for HDMI function on your TV (page 47).
- If your TV is not compatible with the “Control for HDMI-Easy Setting” function, set the Control for HDMI function of the receiver, playback equipment and TV individually (page 48).

If your TV is compatible with the “Control for HDMI-Easy Setting” function

- 1 Connect the receiver, TV and playback equipment via HDMI connection (page 21).
(The respective equipment must be compatible with the Control for HDMI function.)
- 2 Turn on the receiver, TV and playback equipment.
- 3 Turn on the Control for HDMI function of the TV.
The Control for HDMI function of the receiver and all the connected equipment are turned on simultaneously. Wait until “COMPLETE” appears. The setup is complete.

For details on setup of the TV, refer to the operating instructions of your TV.

If your TV is not compatible with the “Control for HDMI-Easy Setting” function

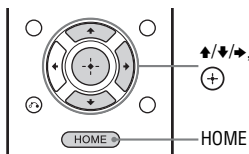

1 Press HOME.

The home menu is displayed on the TV screen.

2 Select “Settings” from the home menu, then press (+).

The Settings menu list appears on the TV screen.

3 Select “HDMI Settings”, then press (+).

4 Select “Control for HDMI”, then press (+).

5 Select “On”, then press (+).

The Control for HDMI function is set to on.

6 Press HOME to exit the OSD menu.

7 Select the HDMI input of the receiver and TV to match the HDMI input of the connected equipment, so that the image from the connected equipment is displayed.

8 Set the Control for HDMI function for the connected equipment to on.

If the Control for HDMI function for the connected equipment is already set to on, you do not need to change the setting.

9 Repeat steps 7 and 8 for other equipment that you want to use the Control for HDMI function.

For details on setting the TV and connected equipment, refer to the operating instructions of the respective equipment.

Notes

- When you unplug the HDMI cable or change the connection, perform the steps given in “If your TV is compatible with the “Control for HDMI-Easy Setting” function” (page 47) or “If your TV is not compatible with the “Control for HDMI-Easy Setting” function” (page 48).
- Before you perform the “Control for HDMI-Easy Setting” on your TV, be sure to turn on the TV and other connected equipment including the receiver first.
- If the playback equipment cannot function after you have made the settings for “Control for HDMI-Easy Setting”, check the Control for HDMI setting of the playback equipment.
- If the connected equipment does not support the “Control for HDMI-Easy Setting”, but still supports the Control for HDMI, then you need to set the Control for HDMI function for the connected equipment before you perform the “Control for HDMI-Easy Setting” from the TV.

One-Touch Play

When you start playback the equipment connected to the receiver via an HDMI connection, the receiver and TV operation are simplified as follows:

Receiver and TV

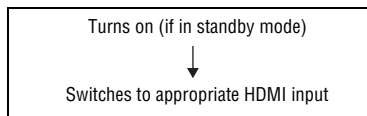

If you set “Pass Through” to “Auto” or “On”* (page 60), then set the receiver to standby mode, sound and image can be output only from the TV.

* For USA, Canada and Australia models only.

Notes

- Be sure that the System Audio Control function is set to on using TV menu.
- Depending on the TV, the start of the content may not appear.
- Depending on the settings, the receiver may not turn on when “Pass Through” is set to “Auto” or “On”.

Tip

You can also select a connected equipment, such as Blu-ray Disc/DVD player from the TV menu. The receiver and TV will automatically switch to the appropriate HDMI input.

System Audio Control

You can enjoy the TV sound from the speakers connected to the receiver by a simple operation.

You can operate System Audio Control function using the TV menu. For details, refer to the operating instructions of the TV.

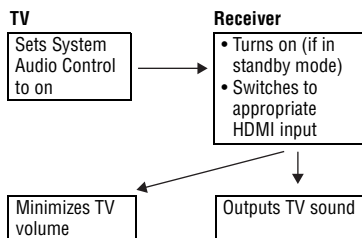

You can also use the System Audio Control function as follows.

- If you turn on the receiver while the TV is turned on, the System Audio Control function will automatically activate to output TV sound through the speakers connected to the receiver. However, if you turn off the receiver, the sound will output from the TV speakers.
- When you enjoy the TV sound from the speakers connected to the receiver, you can adjust the volume or turn off the sound temporarily by using the TV's remote control.

Notes

- If System Audio Control does not function according to your TV setting, refer to the operating instructions of the TV.

- When "Control for HDMI" is set to "On", the "HDMI Audio Out" settings in the HDMI Settings menu will set automatically based on the System Audio Control settings (page 60).
- If the TV is turned on before turning on the receiver, the TV will momentarily lose the sound output.

System Power-Off

When you turn the TV off, using the power button on the TV's remote control, the receiver and the connected equipment turn off automatically.

You can also use the receiver's remote control to turn off the TV.

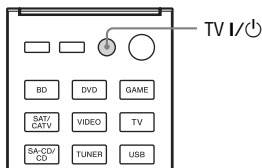

Press TV I/O.

The TV, receiver and the connected equipment are turned off.

Notes

- Set the TV power supply interlock function to on before using the System Power-Off function. For details, refer to the operating instructions of the TV.
- Depending on the condition of the connected equipment, it may not be turned off. For details, refer to the operating instructions of the connected equipment.

Scene Select

The optimum picture quality and sound field are selected automatically according to the scene selected on your TV.

For details on the operation, refer to the operating instructions of the TV.

Note

The sound field may not switch depending on the TV.

Correspondence table

Scene setting on the TV	Sound field
Cinema	HD-D.C.S.
Sports	Sports
Music	Live Concert
Animation	A.F.D. Auto
Photo	A.F.D. Auto
Game	A.F.D. Auto
Graphics	A.F.D. Auto

Home Theatre Control

If a “Home Theatre Control”-compatible TV is connected to the receiver, an icon for Internet based applications appears on the connected TV.

You can switch an input of the receiver or switch sound fields by using your TV’s remote control. You can also adjust the level of the center speaker or the subwoofer, or adjust the settings of “Dual Mono” (page 59) or “A/V Sync.” (page 58).

Note

To use the Home Theatre Control function, your TV must be able to access a broadband service. For details, refer to the operating instructions of your TV.

Remote Easy Control

You can use the TV remote control to operate the menu of the receiver.

Select the receiver (AV AMP) recognized by the TV.

Notes

- The receiver is recognized as “Tuner (AV AMP)” by the TV.
- Your TV must be compatible with the link menu.
- Depending on the type of TV, some of the operations may not be available.

Switching between digital and analog audio (INPUT MODE)

When you connect equipment to both digital and analog audio input jacks on the receiver, you can fix the audio input mode to either of them, or switch from one to the other, depending on the type of material you intend to watch.

- 1 Turn INPUT SELECTOR on the receiver to select the input.**
You can also use the input buttons on the remote control.
- 2 Press INPUT MODE repeatedly on the receiver to select the audio input mode.**

The selected audio input mode appears on the display panel.

- **AUTO:** Gives priority to digital audio signals. If there are more than one digital connection, HDMI audio signals have priority.

If there are no digital audio signals, analog audio signals are selected. When TV input is selected, priority is given to the Audio Return Channel (ARC) signals. If your TV is not compatible with the ARC function, the digital optical audio signals are selected.

If the Control for HDMI functions of both the receiver and the TV are not activated, the ARC does not work.

- **OPT:** Specifies the digital audio signals input to the OPTICAL jack.
- **COAX:** Specifies the digital audio signals input to the COAXIAL jack.
- **ANALOG:** Specifies the analog audio signals input to the AUDIO IN (L/R) jacks.

Notes

- Based on the input, “-----” appears on the display panel, and other modes cannot be selected.
- When “Analog Direct” is being used, audio input is set to “ANALOG”. You cannot select other modes.

Using other audio input jacks (Audio Input Assign)

You can reassign the digital input jacks to other input if the default settings of the jacks do not correspond to your connected equipment.

After you have reassigned the input jacks, you can use the input button (or INPUT SELECTOR on the receiver) to select the equipment you connected.

Example:

When you connect the DVD player to the OPTICAL IN 1 (SAT/CATV) jack.

- Assign the OPTICAL IN 1 (SAT/CATV) jack to “DVD”.

- 1 Select “Settings” from the home menu, then press (+).**
- 2 Select “Input Settings”, then press (+).**
- 3 Select “Audio Input Assign”, then press (+).**
- 4 Select the input name you want to assign.**
- 5 Select the audio signals you want to assign to the input which you selected in step 4 using ↑/↓/←/→.**
- 6 Press (+).**

Input name		BD	DVD	GAME	SAT/ CATV	VIDEO	SA-CD/ CD
Assignable audio input jacks	OPT1	<input type="radio"/>	<input type="radio"/>	<input type="radio"/>	<input type="radio"/> *	<input type="radio"/>	<input type="radio"/>
	OPT2	<input type="radio"/>	<input type="radio"/>	<input type="radio"/>	<input type="radio"/>	<input type="radio"/>	<input type="radio"/>
	COAX	<input type="radio"/>	<input type="radio"/>	<input type="radio"/>	<input type="radio"/>	<input type="radio"/>	<input type="radio"/> *
	None	<input type="radio"/> *	<input type="radio"/> *	<input type="radio"/> *	<input type="radio"/>	<input type="radio"/> *	<input type="radio"/>

* Default setting

Notes

- When you assign the digital audio input, the INPUT MODE setting may change automatically.
- One reassignment is allowed for each input.

Reverting back to the factory default settings

You can clear all memorized settings and revert the receiver back to the factory default settings by performing the following procedure. This procedure can also be used to initialize the receiver before you use it for the first time.

Be sure to use the buttons on the receiver to perform this operation.

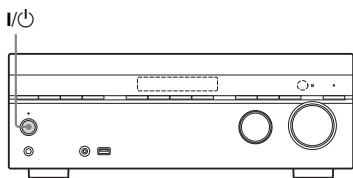

1 Press I/O to turn off the receiver.

2 Hold down I/O for 5 seconds.

The “CLEARING” appears on the display panel for a while, then changes to “CLEARED !”.

Changes or adjustments made to the settings are now reset to the defaults.

Adjusting Settings

Using the Settings menu

You can adjust various settings for speakers, surround effects, etc. using the Settings menu.

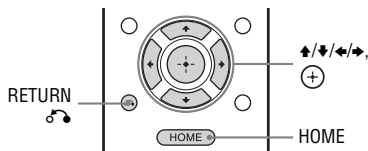

1 Press HOME.

The home menu is displayed on the TV screen.

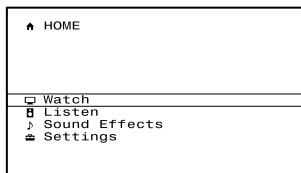

2 Select "Settings" from the menu, then press (+) to enter the menu mode.

The Settings menu list appears on the TV screen.

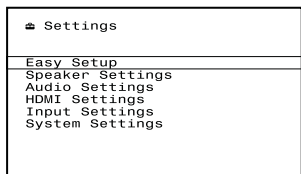

3 Select the menu item you want, then press (+).

Example: When you select "Speaker Settings".

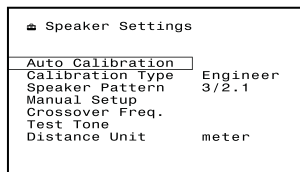

4 Select the parameter you want, then press (+).

To return to the previous screen

Press RETURN ↶.

To exit the menu

Press HOME to display the home menu, then press HOME again.

Settings menu list

Settings	Easy Setup (page 55)		
	Speaker Settings (page 55)	Auto Calibration	
		Calibration Type	Full Flat Engineer Front Ref. Off
		Speaker Pattern	
		Manual Setup	Level Distance Size
		Crossover Freq.	
		Test Tone	
		Distance Unit	feet meter
	Audio Settings (page 58)	Night Mode	
		Equalizer	
		Sound Field	
		A/V Sync.	
		Auto Volume	
		Dual Mono	
		D.Range Comp.	
	HDMI Settings (page 59)	Control for HDMI	
		Pass Through	
		HDMI Audio Out	
		Subwoofer Level	
		Fast View	
	Input Settings (page 60)	Input Mode	
		Input Edit	
		Audio Input Assign	
		Name In	
	System Settings (page 61)	Language	
		Auto Standby	

Note

Menu parameters displayed on the TV screen vary, depending on the current settings or the status of the selected icon.

Easy Setup

Re-runs the Easy Setup to make the basic settings. Follow the on-screen instructions (page 28).

Speaker Settings menu

You can adjust each speaker manually. You can also adjust the speaker levels after the Auto Calibration is completed.

Note

The speaker settings are only for the current seating position.

Auto Calibration

Lets you perform Auto Calibration from your seating position.

- 1 Follow the instructions on the TV screen, then press **+**.

The measurement starts in five seconds. The measurement process will take approximately 30 seconds with a test tone.

When the measurement ends, a beep sounds and the screen switches.

Note

If an error code appears on the screen, see “Message list after Auto Calibration measurement” (page 56).

- 2 Select the item you want, then press **+**.

- **Retry:** Performs the Auto Calibration again.
- **Save&Exit:** Save the measurement results and exits the setting process.
- **WRN Check:** Displays warning related to the measurement results. See “Message list after Auto Calibration measurement” (page 56).
- **Exit:** Exits the setting process without saving the measurement results.

- 3 Save the measurement result.

Select “Save&Exit” in step 2.

Note

If you reposition your speaker, we recommend that you perform Auto Calibration again to enjoy the surround sound.

Tips

- You can change the unit of distance in “Distance Unit” in the Speaker Settings menu (page 58).
- The size of a speaker (“Large”/“Small”) is determined by the low frequency characteristics. The measurement results may vary, depending on the position of the optimizer microphone and speakers, and the shape of the room. It is recommended that you apply the measurement results. However, you can change those settings in the Speaker Settings menu. Save the measurement results first, then try to change the settings.

To check the Auto Calibration results

To check error code or warning message obtained in “Auto Calibration” (page 55), proceed with the following steps.

Select “WRN Check” in step 2 in “Auto Calibration” (page 55) then press **+**.

If a warning message appears, check the message and use the receiver without change.

Or if necessary, perform Auto Calibration again.

When an error code appears

Check the error and perform Auto Calibration again.

- 1 Press **+**.
“Retry?” appears on the TV screen.
- 2 Select “Yes”, then press **+**.
- 3 Repeat steps 1 to 3 in “Auto Calibration” (page 55).

Message list after Auto Calibration measurement

Display and explanation

Error 30

Headphones are connected to the PHONES jack on the receiver. Remove the headphones and perform the Auto Calibration again.

Error 31

The SPEAKERS is set to off. Set to other speaker settings and perform the Auto Calibration again.

Error 32

Error 33

Speakers were not detected or not connected properly.

- None of the front speakers are connected or only one front speaker is connected.
- Either the surround left or surround right speaker is not connected.

The optimizer microphone is not connected. Make sure that the optimizer microphone is connected properly and perform the Auto Calibration again.

If the optimizer microphone is connected properly but the error code still appears, the optimizer microphone cable may be damaged.

Warning 40

The measurement process has completed with high noise level detection. You may be able to achieve better results if you try in a quiet environment again.

Warning 41

Warning 42

The input from the microphone is too big.

- The distance between the speaker and the microphone may be too close. Set them apart and perform the measurement again.
-

Warning 43

The distance and position of a subwoofer cannot be detected. This may be caused by noise. Try to perform the measurement in a quiet environment.

No Warning

There is no warning information.

Tip

Depending on the position of the subwoofer, the measurement results may vary. However, there will be no problems even if you continue to use the receiver with that value.

■ Calibration Type

Lets you select the calibration type after you have performed the Auto Calibration and saved the settings.

- **Full Flat:** Makes the measurement of frequency from each speaker flat.
- **Engineer:** Sets to “the Sony listening room standard” frequency characteristics.
- **Front Ref.:** Adjusts the characteristics of all the speakers to match the characteristics of the front speaker.
- **Off:** Sets the Auto Calibration equalizer level to off.

■ Speaker Pattern

Lets you select the speaker pattern according to the speaker system which you are using.

■ Manual Setup

Lets you adjust each speaker manually on the “Manual Setup” screen. You can also adjust the speaker levels after the Auto Calibration is completed.

To adjust the speaker level

You can adjust each speaker’s level (front left/right, center, surround left/right, subwoofer).

- 1 Select the speaker which you want to adjust the level, then press (+).
- 2 Select the parameter under “Level”, then press (+).
- 3 Adjust the level of the selected speaker, then press (+).

You can adjust the level from -10.0 dB to +10.0 dB in 0.5 dB intervals.

Note

When one of the sound fields for music is selected, no sound is output from the subwoofer if all the speakers are set to “Large” in the Speaker Settings menu. However, the sound will be output from the subwoofer if

- the digital input signal contains LFE signals.
- the front or surround speakers are set to “Small”.
- “Multi Stereo”, “PLII Movie”, “PLII Music”, “HD-D.C.S.” or “Portable Audio” is selected.

To adjust the distance from the seating position to each speaker

You can adjust the distance from the seating position to each speaker (front left/right, center, surround left/right, subwoofer).

- 1 Select the speaker which you want to adjust the distance from the seating position, then press (+).
- 2 Select the parameter under “Distance”, then press (+).
- 3 Adjust the distance of the selected speaker, then press (+).

You can adjust the distance from 1 m 0 cm to 10 m 0 cm (3 feet 3 inches to 32 feet 9 inches) in 1 cm (1 inch) intervals.

Notes

- Depending on the speaker pattern setting, some parameters may not be available.
- This function does not work when “Analog Direct” is being used.

To adjust the size of each speaker

You can adjust each speaker’s (front left/right, center, surround left/right) size.

- 1 Select the speaker which you want to adjust the size, then press (+).
- 2 Select the parameter under “Size”, then press (+).
- 3 Adjust the size of the selected speaker, then press (+).

- **Large:** If you connect large speakers that will effectively reproduce bass frequencies, select “Large”. Normally, select “Large”.

- **Small:** If the sound is distorted, or you feel a lack of surround effects when using multi channel surround sound, select “Small” to activate the bass redirection circuitry and output the bass frequencies of each channel from the subwoofer or other “Large” speakers.

Note

This function does not work when “Analog Direct” is being used.

Tips

- The “Large” and “Small” settings for each speaker determine whether the internal sound processor will cut the bass signal from that channel.

When the bass is cut from a channel, the bass redirection circuitry sends the corresponding bass frequencies to the subwoofer or other “Large” speakers.

However, since bass sound has a certain amount of directionality, it is best not to cut it, if possible. Therefore, even when using small speakers, you can set them to “Large” if you want to output the bass frequencies from that speaker. On the other hand, if you are using a large speaker, but prefer not to have bass frequencies output from that speaker, set it to “Small”.

If the overall sound level is lower than you prefer, set all speakers to “Large”. If there is not enough bass, you can use the equalizer to boost the bass levels.

- When the front speakers are set to “Small”, the center and surround speakers are also automatically set to “Small”.
- If you do not use the subwoofer, the front speakers are automatically set to “Large”.

■ Crossover Freq. (Speaker crossover frequency)

Lets you set the bass crossover frequency of speakers that the speaker size has been set to “Small” in the Speaker Settings menu. Measured speaker crossover frequency is set for each speaker after the Auto Calibration.

- 1 Select the parameter under the speaker which you want to adjust the crossover frequency, then press (+).
- 2 Adjust the value, then press (+).

■ Test Tone

Lets you select the test tone type on the “Test Tone” screen.

Tips

- To adjust the level of all speakers at the same time, press \triangleleft +/- . You can also use MASTER VOLUME on the receiver.
- The adjusted value is shown on the TV screen during adjustment.

To output test tone from each speaker

You can output test tone from the speakers in sequence.

- 1 Select “Test Tone”, then press (+).
- 2 Select “Test Tone” again, then press (+).
- 3 Adjust the parameter, then press (+).
 - **Off**
 - **Auto:** The test tone is output from each speaker in sequence.
- 4 Select the speaker which you want to adjust the speaker level, then press (+).
- 5 Adjust the level of the selected speaker, then press (+).

■ Distance Unit

Lets you select the unit of measurement for setting distances.

- **feet:** The distance is displayed in feet.
- **meter:** The distance is displayed in meters.

Audio Settings menu

You can adjust settings for the audio to suit your preference.

■ Night Mode

Lets you retain a theater-like environment at low volume levels. For details, see “Using the Night Mode function” (page 45).

■ Equalizer

Lets you adjust the bass and treble level for front speakers. For details, see “Adjusting the equalizer” (page 45).

■ Sound Field

Lets you select a sound effect applied to input signals. For details, see “Enjoying Sound Effects” (page 42). You can set the function for each input independently.

■ A/V Sync. (Synchronizes audio with video output)

Lets you delay the output of audio to minimize the time gap between audio output and visual display.

- **On (Delay time: 60 ms):** The audio output is delayed so that the time gap between the audio output and visual display is minimized.
- **Off (Delay time: 0 ms):** The audio output is not delayed.

Notes

- This function is useful when you use a large LCD or plasma monitor or a projector.
- This function does not work when “Analog Direct” is being used.
- The delay time may vary depending on audio format, sound field, speaker pattern and speaker distance settings.

■ Auto Volume

This receiver can adjust the volume automatically depending on the input signal or content from the connected equipment.

This function is useful, for example, when the sound of a commercial is louder than the TV programs.

- **On**
- **Off**

Notes

- Be sure to reduce the volume level before you turn on/off this function.
- As this function is available only when Dolby Digital, DTS or Linear PCM signals are input, the sound may suddenly increase when you switch to other formats.
- This function does not work in the following cases.
 - Linear PCM signals with a sampling frequency of more than 48 kHz are being received.
 - Dolby Digital Plus, Dolby TrueHD, DTS 96/24, DTS-HD Master Audio, or DTS-HD High Resolution Audio signals are being received.

■ Dual Mono (Digital broadcast language selection)

Lets you select the language you want when you listen to the dual audio of a digital broadcast when available. This feature only functions for Dolby Digital sources.

- **Main/Sub:** Sound of the main language will be output through the front left speaker and sound of the sub language will be output through the front right speaker simultaneously.
- **Main:** Sound of the main language will be output.
- **Sub:** Sound of the sub language will be output.

■ D.Range Comp. (Dynamic Range Compression)

Lets you compress the dynamic range of the soundtrack. This may be useful when you want to watch movies at low volumes late at night. Dynamic range compression is possible with Dolby Digital sources only.

- **On:** The dynamic range is compressed as intended by the recording engineer.
- **Auto:** The dynamic range is compressed automatically.
- **Off:** The dynamic range is not compressed.

HDMI Settings menu

You can adjust the required settings for equipment connected to the HDMI jack.

■ Control for HDMI

Lets you turn the Control for HDMI function on or off. For details, see “Preparing for the “BRAVIA” Sync” (page 47).

- **On**
- **Off**

Notes

- When you set “Control for HDMI” to “On”, “HDMI Audio Out” may be changed automatically.
- When the receiver is in standby mode, the I/⏻ indicator on the front panel lights up in amber if “Control for HDMI” is set to “On”.

■ Pass Through

Lets you output the HDMI signals to the TV even when the receiver is in standby mode.

- **On***: When the receiver is in the standby mode, the receiver continuously outputs HDMI signals from the receiver's HDMI TV OUT jack.
- **Auto**: When the TV is turned on while the receiver is in the standby mode, the receiver outputs HDMI signals from the receiver's HDMI TV OUT jack. Sony recommends this setting if you use a "BRAVIA" Sync compatible Sony TV. This setting saves power in the standby mode when compared with the "On" setting.

Note

This setting can only work when "Control for HDMI" is set to "On".

- **Off**: The receiver does not output HDMI signals when in standby mode. Turn on the receiver to enjoy the connected equipment's source on the TV. This setting saves power in the standby mode when compared with the "On" setting.

* For USA, Canada and Australia models only.

Note

When "Auto" is selected, it may take a little more time for the image and sound to be output to the TV than when "On" is selected.

■ HDMI Audio Out

Lets you set the HDMI audio signals output from the playback equipment connected to the receiver via an HDMI connection.

- **AMP**: The HDMI audio signals from the playback equipment are only output to the speakers connected to the receiver. Multi channel sound can be played back as it is.

Note

Audio signals are not output from the TV's speaker when "HDMI Audio Out" is set to "AMP".

- **TV+AMP**: The sound is output from TV's speaker and the speakers connected to the receiver.

Notes

- The sound quality of the playback equipment depends on the TV's sound quality, such as the number of channels, and the sampling frequency, etc. If the TV has stereo speakers, the sound output from the receiver is also in stereo as that of the TV, even if you play back multi channel source.
- When you connect the receiver to a video equipment (projector, etc.), sound may not be output from the receiver. In this case, select "AMP".

■ Subwoofer Level

Lets you set the level of the subwoofer to 0 dB or +10 dB when PCM signals are input via an HDMI connection. You can set the level for each input to which an HDMI input jack is assigned independently.

- **Auto**: Automatically sets the level to 0 dB or +10 dB, depending on the audio stream.
- **+10 dB**
- **0 dB**

■ Fast View

Lets you set the operation of Fast View.

- **Auto**: You can select HDMI input faster than the normal selection.
- **Off**: Fast View and PREVIEW (HDMI) functions are not available.

Input Settings menu

You can adjust the settings for the connections of the receiver and other equipment.

■ Input Mode

Lets you fix the audio input mode when you connect equipment to both digital and analog audio input jacks.

For details, see "Switching between digital and analog audio (INPUT MODE)" (page 51).

■ Input Edit

Lets you set the following items for each input.

- **Watch:** Displays an input to the Watch menu.
- **Listen:** Displays an input to the Listen menu.
- **Watch+Listen:** Displays an input to both the Watch and Listen menus.

■ Audio Input Assign

Lets you set the audio input jack(s) assigned to each input.

For details, see “Using other audio input jacks (Audio Input Assign)” (page 51).

■ Name In

Lets you enter a name of up to 8 characters for inputs and display it.

It is more recognizable having the equipment named on the display than the jacks.

- 1 Select “Name In”, then press \oplus .
- 2 Select the input you want to name, then press \oplus .
- 3 Press \uparrow/\downarrow repeatedly to select a character, then press \rightarrow .
You can move the input position backward and forward by pressing \leftarrow/\rightarrow .
- 4 Repeat step 3 to input a character one by one, then press \oplus .
The name you entered is registered.

System Settings menu

You can adjust the settings of the receiver.

■ Language

Lets you select the language for the messages on the screen.

- English
- French
- German
- Spanish

■ Auto Standby

Lets you set the receiver switch to standby mode automatically when you do not operate the receiver or when there is no signals input to the receiver.

- **On:** Switches to standby mode after approximately 30 minutes.
- **Off:** Does not switch to standby mode.

Notes

- This function does not work when “FM” or “AM” input is selected.
- If you use the Auto standby mode and the Sleep Timer at the same time, the Sleep Timer has priority.

Operating without using the OSD

You can operate this receiver using the display panel even if the TV is not connected to the receiver.

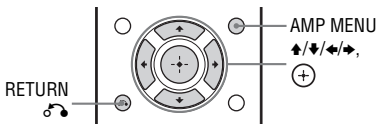

Using the menu on the display panel

- 1 Press AMP MENU.
The menu is displayed on the display panel of the receiver.
- 2 Press \uparrow/\downarrow repeatedly to select the menu you want, then press \oplus .
- 3 Press \uparrow/\downarrow repeatedly to select the parameter you want to adjust, then press \oplus .
- 4 Press \uparrow/\downarrow repeatedly to select the setting you want, then press \oplus .

To return to the previous display

Press **←** or RETURN .

To exit the menu

Press AMP MENU.

Note

Some parameters and settings may appear dimmed on the display panel. This means that they are either unavailable or fixed and unchangeable.

Overview of the menus

The following options are available in each menu. For details on navigating through menus, see page 61.

Menu [Display]	Parameters [Display]	Settings
Auto Calibration settings [<AUTO CAL>]	Auto Calibration start [A.CAL START]	
	Auto Calibration type ^{a)} [CAL TYPE]	FULL FLAT, ENGINEER, FRONT REF, OFF
Level settings [<LEVEL>]	Test tone ^{b)} [TEST TONE]	OFF, AUTO ■■■ ^{c)}
	Front left speaker level [FL LEVEL]	FL -10.0 dB to FL +10.0 dB (0.5 dB interval)
	Front right speaker level [FR LEVEL]	FR -10.0 dB to FR +10.0 dB (0.5 dB interval)
	Center speaker level ^{b)} [CNT LEVEL]	CNT -10.0 dB to CNT +10.0 dB (0.5 dB interval)
	Surround left speaker level ^{b)} [SL LEVEL]	SL -10.0 dB to SL +10.0 dB (0.5 dB interval)
	Surround right speaker level ^{b)} [SR LEVEL]	SR -10.0 dB to SR +10.0 dB (0.5 dB interval)
	Subwoofer level ^{b)} [SW LEVEL]	SW -10.0 dB to SW +10.0 dB (0.5 dB interval)
Speaker settings [<SPEAKER>]	Speaker pattern [SP PATTERN]	3/2.1 to 2/0 (8 patterns)
	Front speakers size ^{b)} [FRT SIZE]	LARGE, SMALL
	Center speaker size ^{b)} [CNT SIZE]	LARGE, SMALL
	Surround speakers size ^{b)} [SUR SIZE]	LARGE, SMALL
	Front left speaker distance [FL DIST.]	FL 1.00 m to FL 10.00 m (FL 3'3" to FL 32'9") (0.01 m (1 inch) interval)
	Front right speaker distance [FR DIST.]	FR 1.00 m to FR 10.00 m (FR 3'3" to FR 32'9") (0.01 m (1 inch) interval)
	Center speaker distance ^{b)} [CNT DIST.]	CNT 1.00 m to CNT 10.00 m (CNT 3'3" to CNT 32'9") (0.01 m (1 inch) interval)

Menu [Display]	Parameters [Display]	Settings
	Surround left speaker distance ^{b)} [SL DIST.]	SL 1.00 m to SL 10.00 m (SL 3'3" to SL 32'9") (0.01 m (1 inch) interval)
	Surround right speaker distance ^{b)} [SR DIST.]	SR 1.00 m to SR 10.00 m (SR 3'3" to SR 32'9") (0.01 m (1 inch) interval)
	Subwoofer distance ^{b)} [SW DIST.]	SW 1.00 m to SW 10.00 m (SW 3'3" to SW 32'9") (0.01 m (1 inch) interval)
	Distance unit [DIST. UNIT]	FEET, METER
	Front speakers crossover frequency ^{d)} [FRT CROSS]	CROSS 40 Hz to CROSS 200 Hz (10 Hz interval)
	Center speaker crossover frequency ^{d)} [CNT CROSS]	CROSS 40 Hz to CROSS 200 Hz (10 Hz interval)
	Surround speakers crossover frequency ^{d)} [SUR CROSS]	CROSS 40 Hz to CROSS 200 Hz (10 Hz interval)
Input settings [<INPUT>]	Input mode [INPUT MODE]	AUTO, OPT, COAX, ANALOG
	Naming inputs [NAME IN]	For details, see "Name In" (page 61).
	Digital audio input assignment [A. ASSIGN]	For details, see "Using other audio input jacks (Audio Input Assign)" (page 51).
Surround settings [<SURROUND>]	Effect level ^{e)} [HD-D.C.S. TYP]	DYNAMIC, THEATER, STUDIO
EQ settings [<EQ>]	Front speakers bass level [BASS]	BASS -10 dB to BASS +10 dB (1 dB interval)
	Front speakers treble level [TREBLE]	TREBLE -10 dB to TREBLE +10 dB (1 dB interval)
Tuner settings [<TUNER>]	FM station receiving mode [FM MODE]	STEREO, MONO
	Naming preset stations [NAME IN]	For details, see "Naming preset stations (Name Input)" (page 41).

Menu [Display]	Parameters [Display]	Settings
Audio settings [<AUDIO>]	Night mode [NIGHT MODE]	NIGHT ON, NIGHT OFF
	Synchronizes audio with video output [A/V SYNC]	SYNC ON, SYNC OFF
	Advanced auto volume [AUTO VOL]	A. VOL ON, A. VOL OFF
	Digital broadcast language selection [DUAL MONO]	MAIN/SUB, MAIN, SUB
	Dynamic range compression [D. RANGE]	COMP. ON, COMP. AUTO, COMP. OFF
HDMI settings [<HDMI>]	Control for HDMI [CTRL: HDMI]	CTRL ON, CTRL OFF
	Pass Through [PASS THRU]	ON ^{d)} , AUTO, OFF
	HDMI audio out [AUDIO OUT]	AMP, TV+AMP
	HDMI subwoofer level [SW LEVEL]	SW AUTO, SW +10 dB, SW 0 dB
	Fast view [FAST VIEW]	AUTO, OFF
System settings [<SYSTEM>]	Auto standby mode [AUTO STBY]	STBY ON, STBY OFF
	Version [VER. x.xxx] ^{g)}	

a) You can select this setting only when you have performed the Auto Calibration and saved the settings.

b) Depends on the speaker pattern setting, some parameters or settings may not be available.

c) ■■■■ represent a speaker channel (FL, FR, CNT, SL, SR, SW).

d) You can only select this parameter if your speaker is set to "SMALL".

e) You can only select this parameter if you select "HD-D.C.S." as sound field.

f) For USA, Canada and Australia models only.

g) x.xxx represent a version number.

To view the information on the display panel

The display panel provides various information of the receiver status such as sound field.

- 1 Select the input for which you want to check the information.
- 2 Press AMP, then press DISPLAY repeatedly.

Each time you press DISPLAY, the display will change cyclically as follows.

Index name of the input¹⁾ → Input you selected → Sound field currently applied²⁾ → Volume level → Stream information³⁾

When listening to FM and AM radio

Preset station name¹⁾ → Frequency → Sound field currently applied²⁾ → Volume level

When receiving RDS broadcasts (Europe and Australia models only)

Program Service name or preset station name¹⁾ → Frequency, band and preset number → Sound field currently applied²⁾ → Volume level

- ¹⁾ Index name appears only when you have assigned one to the input or preset station. Index name does not appear when only blank spaces have been entered or it is same as the input name.
- ²⁾ "PURE.DIRECT" appears when Pure Direct function is activated.
- ³⁾ Stream information may not be displayed.

Note

Character or marks may not be displayed for some languages.

Using the Remote Control

Reassigning the input button

You can change the default settings of the input buttons to suit the equipment in your system. For example, if you connect a Blu-ray Disc player to the SAT/CATV jack on the receiver, you can set the SAT/CATV button on this remote to control the Blu-ray Disc player.

Note

You cannot reassign the TV, TUNER and USB input buttons.

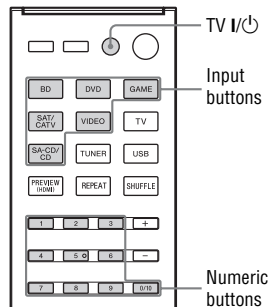

- 1 While holding down the input button of which you want to change the assignment, hold down TV I/O.**

Example: While holding down SAT/CATV, hold down TV I/O.

- 2 With the TV I/O button held, release the input button.**

Example: With the TV I/O button held, release SAT/CATV.

3 Referring to the following table, press the corresponding button for the category you want, then release TV I/⏻.

Example: Press 1, then release TV I/⏻.
Now you can use the SAT/CATV button to control the Blu-ray Disc player.

Categories	Press
Blu-ray Disc player (command mode BD1) ^{a)}	1
Blu-ray Disc recorder (command mode BD3) ^{a)}	2
DVD player (command mode DVD1)	3
DVD recorder (command mode DVD3) ^{b)}	4
VCR (command mode VTR3) ^{c)}	5
CD player	6

^{a)} For details on the BD1 or BD3 setting, refer to the operating instructions supplied with the Blu-ray Disc player or Blu-ray Disc recorder.

^{b)} Sony DVD recorders are operated with a DVD1 or DVD3 setting. For details, refer to the operating instructions supplied with the DVD recorders.

^{c)} Sony VCRs are operated with a VTR 3 setting which corresponds to VHS.

Resetting the input buttons

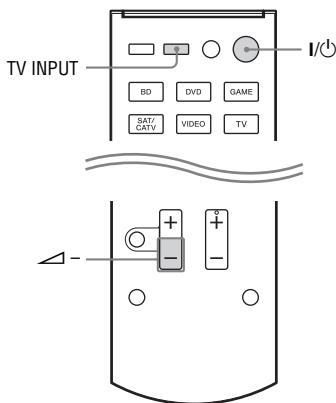

1 While holding down , press and hold I/⏻, then press TV INPUT.

2 Release all buttons.
The input buttons are reset to the default settings.

Precautions

On safety

Should any solid object or liquid fall into the cabinet, unplug the receiver and have it checked by qualified personnel before operating it any further.

On power sources

- Before operating the receiver, check that the operating voltage is identical with your local power supply.
The operating voltage is indicated on the nameplate on the back of the receiver.
- The unit is not disconnected from the AC power source (mains) as long as it is connected to the wall outlet, even if the unit itself has been turned off.
- If you are not going to use the receiver for a long time, be sure to disconnect the receiver from the wall outlet. To disconnect the AC power cord (mains lead), grasp the plug itself; never pull the cord.
- (USA and Canada models only)
One blade of the plug is wider than the other for the purpose of safety and will fit into the wall outlet only one way. If you are unable to insert the plug fully into the outlet, contact your dealer.
- The AC power cord (mains lead) must be changed only at a qualified service shop.

On heat buildup

Although the receiver heats up during operation, this is not a malfunction. If you continuously use this receiver at a large volume, the cabinet temperature of the top, side and bottom rises considerably. To avoid burning yourself, do not touch the cabinet.

On placement

- Place the receiver in a location with adequate ventilation to prevent heat buildup and prolong the life of the receiver.
- Do not place the receiver near heat sources, or in a place subject to direct sunlight, excessive dust, or mechanical shock.
- Do not place anything on top of the cabinet that might block the ventilation holes and cause malfunctions.
- Do not place the receiver near equipment such as a TV, VCR, or tape deck. (If the receiver is being used in combination with a TV, VCR, or tape deck, and is placed too close to that equipment, noise may result, and picture quality may suffer. This is especially likely when using an indoor antenna (aerial). Therefore, we recommend using an outdoor antenna (aerial).)
- Use caution when placing the receiver on surfaces that have been specially treated (with wax, oil, polish, etc.) as staining or discoloration of the surface may result.

On operation

Before connecting other equipment, be sure to turn off and unplug the receiver.

On cleaning

Clean the cabinet, panel, and controls with a soft cloth slightly moistened with a mild detergent solution. Do not use any type of abrasive pad, scouring powder, or solvent, such as alcohol or benzine.

If you have any questions or problems concerning your receiver, please consult your nearest Sony dealer.

Troubleshooting

If you experience any of the following difficulties while using the receiver, use this troubleshooting guide to help you remedy the problem. Should any problem persists, consult your nearest Sony dealer. Note that if service personnel changes some parts during repair, these parts may be retained.

Power

The receiver is turned off automatically.

- “Auto Standby” is set to “On” (page 61).
- The Sleep Timer function is working (page 15).
- “PROTECTOR” is working (page 75).

Image

No image appears on the TV.

- Select the appropriate input using the input buttons.
- Set your TV to the appropriate input mode.
- Move your audio equipment away from the TV.
- Make sure that cables are correctly and securely connected to equipment.
- Depending on the playback equipment, you may need to set up the equipment. Refer to the operating instructions supplied with each equipment.
- Be sure to use a High Speed HDMI cable when you view images or listen to sound, especially for the 1080p, Deep Color (Deep Colour), 4K or 3D transmission.

No 3D image appears on the TV.

- Depending on the TV or the video equipment, 3D images may not be displayed.

No 4K image appears on the TV.

- Depending on the TV or video equipment, 4K images may not be displayed. Check the video capability and setting of your TV and video device. Also, make sure to connect the video equipment to 4K available HDMI IN jack of the receiver.

When the receiver is in standby mode, there is no image output from the TV.

- When the receiver enters into standby mode, image is from the last HDMI equipment selection before you turned off the receiver. If you are enjoying other equipment, play the equipment and perform the One-Touch Play operation, or turn on the receiver to select the HDMI equipment you want to enjoy.
- (For USA, Canada and Australia models only)
Make sure “Pass Through” is set to “On” in the HDMI Settings menu if you connect equipment not compatible with the “BRAVIA” Sync to the receiver (page 60).

The OSD menu does not appear on the TV screen.

- Press HOME to turn the OSD on.
- Check that the TV is connected correctly.
- Depending on the TV, the OSD menu may take some time to appear on the TV screen.

Display panel is turned off.

- If PURE DIRECT indicator lights up, press PURE DIRECT to turn off the function (page 46).
- Press DIMMER on the receiver to adjust the brightness of the display panel.

Sound

There is no sound, no matter which equipment is selected, or only a very low-level sound is heard.

- Check that all connecting cords are inserted to their input/output jacks for the respective jacks of the receiver, speakers and the equipment.
- Check that both the receiver and all equipment are turned on.
- Check that MASTER VOLUME control is not set to “VOL MIN”.
- Check that the SPEAKERS is not set to “SPK OFF” (page 10).
- Check that headphones are not connected to the receiver.
- Press  on the remote control to cancel the muting function.
- Try pressing the input button on the remote control or turning the INPUT SELECTOR on the receiver to select the equipment of your choice (page 32).
- When you want to listen to the sound from the TV speaker, set the “HDMI Audio Out” to “TV+AMP” in the HDMI Settings menu (page 60). If you cannot play back multi channel audio source, set to “AMP”. However, the sound will not output through the TV speaker.
- Sound may be interrupted when the sampling frequency, the number of channels or audio format of audio output signals from the playback equipment is switched.

There is severe hum or noise.

- Check that the speakers and equipment are connected securely.
- Check that the connecting cords are away from a transformer or motor, and at least 3 meters (10 feet) away from a TV set or fluorescent light.
- Move your audio equipment away from the TV.

- The plugs and jacks are dirty. Wipe them with a cloth slightly moistened with alcohol.

There is no sound, or only a very low-level sound is heard from specific speakers.

- Connect a pair of headphones to the PHONES jack to verify that sound is output from the headphones. If only one channel is output from the headphones, the equipment may not be connected to the receiver correctly. Check that all the cords are fully inserted into the jacks on both the receiver and the equipment. If both channels are output from the headphones, the front speaker may not be connected to the receiver correctly. Check the connection of the front speaker which is not outputting any sound.
- Make sure you have connected to both the L and R jacks of an analog equipment, analog equipment requires both L and R jack connections. Use an audio cord (not supplied).
- Adjust the speaker level (page 56).
- Check that the speaker settings are appropriate for the setup using the “Auto Calibration” or “Speaker Pattern” in the Speaker Settings menu. Then check that sound is output from each speaker correctly, using “Test Tone” in the Speaker Settings menu.
- Check that the subwoofer is connected correctly and securely.
- Make sure you have turned on your subwoofer.
- Depending on the selected sound field, no sound will be available from the subwoofer.
- When all speakers are set to “Large” and “Neo:6 Cinema” or “Neo:6 Music” is selected, there is no sound from the subwoofer.

There is no sound from a specific equipment.

- Check that the equipment is connected correctly to the audio input jacks for that equipment.
- Check that the cord(s) used for the connection is (are) fully inserted into the jacks on both the receiver and the equipment.
- Check the INPUT MODE (page 51).
- Check that the equipment is connected correctly to the HDMI jack for that equipment.
- You cannot listen to the Super Audio CD by connecting HDMI.
- Depending on the playback equipment, you may need to set up the HDMI setting of the equipment. Refer to the operating instructions supplied with each equipment.
- Be sure to use a High Speed HDMI cable when you view images or listen to sound, especially for the 1080p, Deep Color (Deep Colour), 4K or 3D transmission.
- Audio signals (format, sampling frequency, bit length, etc.) transmitted from an HDMI jack may be suppressed by the connected equipment. Check the setup of the connected equipment if the image is poor or the sound does not come out of the equipment connected via the HDMI cable.
- When the connected equipment is not compatible with copyright protection technology (HDCP), the image and/or the sound from the HDMI TV OUT jack may be distorted or may not be output. If this is the case, check the specification of the connected equipment.
- Set the image resolution of the playback equipment to more than 720p/1080i to enjoy High Bitrate Audio (DTS-HD Master Audio, Dolby TrueHD).
- The image resolution of the playback equipment may need to be at certain settings before you can enjoy Multi Channel Linear PCM. Refer to the operating instructions of the playback equipment.
- Make sure the TV is compatible with the System Audio Control function.
- If the TV does not have System Audio Control function, set the “HDMI Audio Out” settings in HDMI Settings menu to
 - “TV+AMP” if you want to listen to the sound from the TV speaker and receiver.
 - “AMP” if you want to listen to the sound from the receiver.
- When you connect the receiver to a video equipment (projector, etc.), sound may not be output from the receiver. In this case, set the “HDMI Audio Out” to “AMP” in the HDMI Settings menu (page 60).
- If you cannot listen to the sound of the equipment connected to the receiver while TV input is selected on the receiver
 - Be sure to change the input of the receiver to HDMI when you want to watch a program on the equipment connected via HDMI connection to the receiver.
 - Change the TV channel when you want to watch a TV broadcast.
 - Be sure to select the correct equipment or input you want when you watch a program from the equipment connected to the TV. Refer to the operating instructions of the TV on this operation.
- Check that the “Analog Direct” is not being used.
- When using the Control for HDMI function, you cannot control the connected equipment using TV’s remote control.

- Depending on the connected equipment and TV, you may need to set up the equipment and TV. Refer to the operating instructions supplied with each equipment and TV.
- Change the input of the receiver to the HDMI input connected to the equipment.
- Check that the selected digital audio input jack is not reassigned to other inputs (page 51).

The left and right sounds are unbalanced or reversed.

- Check that the speakers and equipment are connected correctly and securely.
- Adjust the sound level parameters using the Speaker Settings menu.

Dolby Digital or DTS multi channel sound is not reproduced.

- Check that the DVD, etc. you are playing is recorded in Dolby Digital or DTS format.
- When connecting the DVD player, etc., to the digital input jacks of this receiver, make sure the digital audio output setting of the connected equipment is available.
- Set “HDMI Audio Out” to “AMP” in the HDMI Settings menu (page 60).
- You can enjoy High Bitrate Audio (DTS-HD Master Audio, Dolby TrueHD), Multi Channel Linear PCM only with an HDMI connection.

The surround effect cannot be obtained.

- Make sure you have selected the sound field for movie or music (page 42).
- Sound fields do not function when DTS-HD Master Audio, DTS-HD High Resolution Audio or Dolby TrueHD with sampling frequency of more than 48 kHz are being received.

A test tone is not output from the speakers.

- The speaker cords may not be connected securely. Check to see if they are connected securely and cannot be disconnected by pulling on them slightly.
- The speaker cords may have short-circuit problem.

A test tone is output from a different speaker than the speaker displayed on the TV screen.

- The speaker pattern set up is incorrect. Make sure that the speaker connections and the speaker pattern match correctly.

When the receiver is in standby mode, there is no sound output from the TV.

- When the receiver enters into standby mode, sound is from the last HDMI equipment selection before you turned off the receiver. If you are enjoying other equipment, play the equipment and perform the One-Touch Play operation, or turn on the receiver to select the HDMI equipment you want to enjoy.
- (For USA, Canada and Australia models only)
Make sure “Pass Through” is set to “On” in the HDMI Settings menu if you connect equipment not compatible with the “BRAVIA” Sync to the receiver (page 60).

Tuner

The FM reception is poor.

- Use a 75-ohm coaxial cable (not supplied) to connect the receiver to an outdoor FM antennas (aerial) as shown below.

Outdoor FM antenna (aerial)

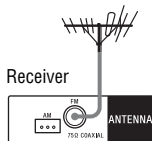

Radio stations cannot be tuned in.

- Check that the antennas (aerials) are connected securely. Adjust the antennas (aerials) and connect an external antenna (aerial), if necessary.
- The signal strength of the stations is too weak with automatic tuning. Use direct tuning.
- Make sure you set the tuning scale correctly (when tuning in AM stations with direct tuning) (page 40).
- No stations have been preset or the preset stations have been cleared (when tuning by scanning preset stations is used). Preset the stations (page 41).
- Press AMP, then press DISPLAY repeatedly on the remote control so that the frequency appears on the display panel.

RDS does not work.*

- Make sure that you are tuned to an FM RDS station.
- Select a stronger FM station.
- The station you tuned to is not transmitting the RDS signal or the signal strength is weak.

The RDS information that you want does not appear.*

- The service may be temporarily out of order. Contact the radio station and find out whether they actually provide the service in question.

* Europe and Australia models only.

iPod/iPhone

The sound is distorted.

- Press – on the remote control repeatedly.
- Set the “EQ” setting of the iPod/iPhone to “Off” or “Flat”.

There is no sound from the iPod/iPhone.

- Disconnect the iPod/iPhone and connect the iPod/iPhone again.

The iPod/iPhone cannot be charged.

- Check that the receiver is turned on.
- Make sure the iPod/iPhone is connected firmly.

The iPod/iPhone cannot be operated.

- Check that you have removed the protect case of the iPod/iPhone.
- Depending on the contents of the iPod/iPhone, it may take time to start playback.
- Disconnect the iPod/iPhone and connect the iPod/iPhone again.
- You are using an unsupported iPod/iPhone. See “Compatible iPod/iPhone models” (page 33) for the supported device types.

The ring volume of the iPhone does not change.

- Adjust the ring volume using the controls on the iPhone.

USB device

Are you using a supported USB device?

- If you connect an unsupported USB device, the following problems may occur. See “Compatible USB devices” (page 36) for the supported device types.
 - The USB device is not recognized.

- File or folder names are not displayed on this receiver.
- Playback is not possible.
- The sound skips.
- There is noise.
- A distorted sound is output.

There is noise, skipping, or distorted sound.

- Turn off the receiver and reconnect the USB device, then turn on the receiver.
- The music data itself contains noise, or the sound is distorted.

The USB device is not recognized.

- Turn off the receiver, then disconnect the USB device. Turn on the receiver again and reconnect the USB device.
- Connect the supported USB device (page 36).
- The USB device does not work properly. Refer to the USB device operating instructions on how to deal with this problem.

Playback does not start.

- Turn off the receiver and reconnect the USB device, then turn on the receiver.
- Connect the supported USB device (page 36).
- Press ► to start playback.

The USB device cannot be connected into the ψ (USB) port.

- The USB device is being connected upside down. Connect the USB device in the correct orientation.

Erroneous display.

- The data stored in the USB device may have been corrupted.
- The character codes that can be displayed by this receiver are as follows:
 - Upper cases (A to Z)
 - Lower cases (a to z)
 - Numbers (0 to 9)
 - Symbols (' = < > * + , - . / @ [\] _ `)Other characters may not be displayed correctly.

“Reading” is displayed for an extended time, or it takes a long time before playback starts.

- The reading process can take a long time in the following cases.
 - There are many folders or files on the USB device.
 - The file structure is extremely complex.
 - The memory capacity is excessive.
 - The internal memory is fragmented. Thus, we recommend following these guidelines.
 - Total folders on USB device: 256 or less (including “ROOT” folder)
 - Total files per folder: 256 or less.

Audio file cannot be played back.

- MP3 files in MP3 PRO format cannot be played back.
- The audio file is a multiple track audio file.
- Some AAC files may not be played back correctly.
- WMA files in Windows Media Audio Lossless and Professional format cannot be played back.
- USB device formatted with file systems other than FAT16 or FAT32 are unsupported.*
- If you use partitioned USB device, only audio files on the first partition can be played back.
- Playback is possible up to 8 levels (including “ROOT” folder).
- The number of folders has exceeded 256 (including “ROOT” folder).
- The number of files in a folder has exceeded 256.
- Files that are encrypted or protected by passwords, etc. cannot be played back.

* This unit supports FAT16 and FAT32, but some USB device may not support all of these FAT.
For details, refer to the operating instructions of each USB device or contact the manufacturer.

“BRAVIA” Sync (Control for HDMI)

The Control for HDMI function does not work.

- Check the HDMI connection (page 22).
- Make sure “Control for HDMI” is set to “On” in HDMI Settings menu.
- Make sure the connected equipment is compatible with the Control for HDMI function.
- Check the Control for HDMI settings on the connected equipment. Refer to the operating instructions of the connected equipment.
- If you unplug the HDMI cable or change the connection, repeat the procedures of “Preparing for the “BRAVIA” Sync” (page 47).
- When “Control for HDMI” is set to “Off”, the “BRAVIA” Sync does not work properly, even if the equipment is connected to the HDMI IN jack.
- The types and the number of equipment which can be controlled by the “BRAVIA” Sync are restricted in the HDMI CEC standard as follows.
 - Recording equipment (Blu-ray Disc recorder, DVD recorder, etc.): up to 3 equipment
 - Playback equipment (Blu-ray Disc player, DVD player, etc.): up to 3 equipment
 - Tuner-related equipment: up to 4 equipment (The receiver uses one of them for its OSD operations.)
 - AV receiver (audio system): up to 1 equipment

Remote control

The remote control does not function.

- Point the remote control at the remote control sensor on the receiver (page 10).
- Remove any obstacles in the path between the remote control and the receiver.
- Replace all the batteries in the remote control with new ones, if they are weak.
- Make sure you select the correct input on the remote control.

Error messages

If there is a malfunction, a message appears on the display panel. You can check the condition of the system by the message. If any problem persists, consult your nearest Sony dealer.

PROTECTOR

Irregular current is output to the speakers, or the receiver is covered and ventilation holes are blocked. The receiver will automatically turn off after a few seconds. Remove the object covering the upper panel of the receiver, check the speaker connection and turn on the power again.

USB FAIL

An over current from the ψ (USB) port was detected. The receiver will automatically turn off after a few seconds. Check the iPod/iPhone or USB device, then unplug it and turn on the power again.

For other messages, see “Message list after Auto Calibration measurement” (page 56), “iPod/iPhone message list” (page 35) and “USB message list” (page 38).

Clearing the memory

Reference sections

To clear	See
All memorized settings	page 52
Customized sound fields	page 46

Specifications

AUDIO POWER SPECIFICATIONS

POWER OUTPUT AND TOTAL HARMONIC DISTORTION: (USA model only)

With 6 ohm loads, both channels driven, from 20 – 20,000 Hz; rated 90 watts per channel minimum RMS power, with no more than 0.09% total harmonic distortion from 250 milliwatts to rated output.

Amplifier section

Power Output¹⁾

Minimum RMS Output Power
(6 ohms, 20 Hz – 20 kHz, THD 0.09%)
90 W + 90 W

Stereo Mode Output Power
(6 ohms, 1 kHz, THD 1%)
105 W + 105 W

Surround Mode Output Power²⁾
(6 ohms, 1 kHz, THD 0.9%)
145 W per channel

¹⁾ Measured under the following conditions:

Area	Power requirements
USA, Canada	120 V AC, 60 Hz
Europe, Australia	230 V AC, 50 Hz

²⁾ Reference power output for front, center and surround speakers. Depending on the sound field settings and the source, there may be no sound output.

Frequency response

Analog
10 Hz – 100 kHz, +0.5/-2 dB (with sound field and equalizer bypassed)

Input

Analog
Sensitivity: 500 mV/50 kilohms
S/N³⁾: 105 dB (A, 500 mV⁴⁾)

Digital (Coaxial)

Impedance: 75 ohms

S/N: 100 dB (A, 20 kHz LPF)

Digital (Optical)

S/N: 100 dB (A, 20 kHz LPF)

Output (Analog)

SUBWOOFER

Voltage: 2 V/1 kilohm

Equalizer

Gain levels

±10 dB, 1 dB step

³⁾ INPUT SHORT (with sound field and equalizer bypassed).

⁴⁾ Weighted network, input level.

FM tuner section**Tuning range**

87.5 MHz – 108.0 MHz

Antenna (aerial)

FM wire antenna (aerial)

Antenna (aerial) terminals

75 ohms, unbalanced

AM tuner section**Tuning range**

Area	Tuning scale	
	10 kHz step	9 kHz step
USA, Canada	530 kHz – 1,710 kHz	531 kHz – 1,710 kHz
Europe, Australia	–	531 kHz – 1,602 kHz

Antenna (aerial)

Loop antenna (aerial)

Video section**Inputs/Outputs**

Video:

1 Vp-p, 75 ohms

iPod/iPhone section

DC 5V 1.0 A MAX

USB section**Supported format***

MP3 (MPEG 1 Audio Layer-3):

32 kbps – 320 kbps, VBR

WMA:

48 kbps – 192 kbps

AAC:

48 kbps – 320 kbps

WAV:

8 kHz – 48 kHz 16 bit PCM

* Compatibility with all encoding/writing software, recording devices and recording media cannot be guaranteed.

Transfer speed

Full-speed

Supported USB device

Mass Storage Class

Maximum current

500 mA

General**Power requirements**

Area	Power requirements
USA, Canada	120 V AC, 60 Hz
Europe	230 V AC, 50/60 Hz
Australia	230 V AC, 50 Hz

Power consumption

200 W

Power consumption (during standby mode)

0.3 W (When “Control for HDMI” (page 59) and “Pass Through” (page 60) are set to “Off”.)

Dimensions (width/height/depth) (Approx.)

430 mm × 156 mm × 329.4 mm
(17 in × 6 1/4 in × 13 in) including projecting parts and controls

Mass (Approx.)

7.7 kg (16 lb 16 oz)

Design and specifications are subject to change without notice.

Index

Numerics

- 2 channel 42
- 5.2 channel 19

A

- A.F.D./2CH mode 42
- A/V Sync. 58, 65
- AM 39
- Audio Input Assign 51
- Audio Settings 58, 65
- Auto Calibration Settings 63
- Auto Standby 61, 65
- Auto Tuning 39
- Auto Volume 59

B

- Bass 45, 64
- Blu-ray Disc player 24
- BRAVIA Sync
 - preparing 47

C

- Cable TV tuner 24, 25
- Calibration Type 56, 63
- CD player 26
- Clear
 - memory 52
 - remote control 67
 - sound field 46
- Connection
 - antennas 27
 - audio equipment 26
 - iPod/iPhone 26
 - speakers 20
 - TV 21

- USB device 26
- video equipment 22
- Control for HDMI 59, 65
- Crossover frequency 58, 64

D

- DCAC (Digital Cinema Auto Calibration) 28
- Direct Tuning 40
- Display panel 11
- Distance Unit 58, 64
- Dual Mono 59, 65
- DVD player 24
- DVD recorder 25
- Dynamic range compression 59, 65

E

- Easy Setup 28
- Effect level 64
- EQ Settings 45, 64

F

- Fast View 60
- FM 39
- FM Mode 39, 64

H

- HD-D.C.S. 43
- HDMI Audio Out 60, 65
- HDMI Settings 59, 65
- Home Theatre Control 50

I

- Input 31
- INPUT MODE 51
- Input Settings 60
- iPod/iPhone 33

L

- Language 61
- Level Settings 63

M

- Manual Setup 56
- Menu 53, 63
- Message
 - Auto Calibration 56
 - Error 75
 - iPod/iPhone 35
 - USB 38

- Movie mode 43
- Music mode 44
- Muting 32

N

- Name Input 41, 61
- Night mode 10, 58

O

- One-Touch Play 48
- OSD (On-Screen Display) 30

P

- Pass Through 60, 65
- PlayStation 3 24
- Preset stations 41
- PROTECTOR 75
- Pure Direct 46

R

- Remote control 14
- Remote Easy Control 50
- Resetting 52

S

- Satellite tuner 24, 25
- Scene Select 50
- Settings menu 53
- Sleep Timer 15
- Sound field 42
- Speaker Pattern 56, 63
- Speaker Settings 55, 63
- Super Audio CD player 26
- Surround Settings 64
- System Audio Control 49
- System Power-Off 49
- System Settings 61, 65

T

- Test Tone 58, 63
- Treble 45, 64
- Tuner 39
- Tuner Settings 64
- TV 21

U

- USB FAIL 75

V

- VCR 25
- Video game 25
- Viewing information on the display panel 66

Made for



iPod



iPhone

HDMI

<http://www.sony.net/>

4-448-425-13(1)



* 4 4 4 8 4 2 5 1 3 * (1)